

The **LIFT** House:

An amphibious strategy for sustainable and affordable housing for the urban poor in flood-prone Bangladesh

by
Prithula Prosun

A thesis
presented to the University of Waterloo
in fulfillment of the
thesis requirement for the degree of
Master of Architecture

Waterloo, Ontario, Canada, 2011
© Prithula Prosun 2011

AUTHOR'S DECLARATION

I hereby declare that I am the sole author of this thesis. This is a true copy of the thesis, including any required final revisions, as accepted by my examiners.

I understand that my thesis may be made electronically available to the public.

ABSTRACT

Bangladesh is known for two things: poverty and floods. It is a delta country burdened with draining large amounts of water from surrounding countries and a heavy monsoon season that have caused numerous severe floods with large scale destruction throughout the country. Rapid urbanization and migration have put an immense pressure on the urban centres. Dhaka, the capital city and the largest urban centre of the country, is struggling to provide adequate housing and basic services for the urban poor who are forced to find accommodation in the flood-prone slums and squatter settlements of the city. The alarming rate of population growth further aggravates the problem of environmental degradation which in turn causes more severe floods. As one of the most vulnerable countries for climate change, Bangladesh must work towards providing flood-resilient, safe and affordable housing for all its citizens.

My response was the LIFT (Low Income Flood-proof Technology) House: an affordable, flood-resilient housing solution for the low income families of Dhaka. The LIFT house consists of two amphibious structures that are capable of adapting to rising water levels. The amphibious structures float up on buoyant foundations during floods, and return to ground level when water recedes. It is a sustainable, environmentally friendly house that provides all basic services to its residents without connection to the city service systems, through the use of indigenous materials and local skills.

This thesis documents the research, design, and construction of the LIFT house with funding provided by the International Development Research Centre (IDRC). The LIFT house was completed on January 2010 in Dhaka, Bangladesh, and has become a symbol for the city's desire to provide sustainable, low-cost accommodations that are protected from floods.

ACKNOWLEDGEMENTS

This thesis is indebted to the contributions of the following individuals and organizations:

Dr. Elizabeth English, thesis supervisor

Rick Haldenby, thesis advisor

Lloyd Hunt, thesis advisor

Mr. Mannan Khan and the Ministry of Public Works

ABC Construction Ltd., engineering consultancy and contractor

Housing and Building Research Institute, construction support

ILCB Dhaka, administration support

CUS Dhaka, research support

Ajay Chowdhury, Centennial Solar

Srabanti Datta, head of business development of ABC Const. Ltd.

Md. Abul Kalam Azad, site engineer

Md. Atyar Rahman, site supervisor

Md. Abu Selim Mollah, structural engineer

Md. Nafizur Rahman, research architect of HBRI

M.A. Wahed, senior research engineer of HBRI

Dyutee Fahima Naz, architect

Salma Shafi, Architect and Urban Planner

Andrew Levitt, University of Waterloo professor

Kathy Velikov, University of Waterloo professor

Khashayar Toutounchian, University of Waterloo student

Sara Nejad, University of Waterloo student

Manash Kr. Mitra, mechanical engineer

Dr. Shayer Gafur, BUET architecture professor

Md. Imrul Khayes, Architecture for Humanity representative

Dr. Saiful Huque, solar engineer

Md. Sirajul Islam, Dhaka deputy town planner

Nur Mohammed Sarker, Grameen Shakti

DEDICATION

To my parents, sister and husband. Your love and unbelievable support are the foundations to my life and this thesis.

TABLE OF CONTENTS

	AUTHOR'S DECLARATION	ii
	ABSTRACT	iii
	ACKNOWLEDGEMENTS	iv
	DEDICATION	v
	TABLE OF CONTENTS	vi
	LIST OF ILLUSTRATIONS	vii
	INTRODUCTION	1
1.0	ON LAND	3
2.0	ON WATER	16
3.0	HOUSING	23
4.0	THE REALITY OF BASTEES	27
	NARRATIVE: JANUARY 2009	35
5.0	AMPHIBIOUS ARCHITECTURE	37
6.0	THE ENVIRONMENT	43
	NARRATIVE: JULY 2009	49
	NARRATIVE: AUGUST 2009	54
7.0	THE LIFT HOUSE	58
	NARRATIVE: SEPTEMBER 2009	73
8.0	THE CONSTRUCTION	76
	NARRATIVE: NOVEMBER 2009 - JANUARY 2010	76
9.0	CONCLUSION	153
	APPENDICES	
A.1	IDRC PROPOSAL	164
A.2	LIFT BROCHURE	177
A.3	LIFT PROPOSAL BOOKLET	178
A.4	LIFT HOUSE PILOT PROJECT CONSTRUCTION COST	180
	BIBLIOGRAPHY	181

LIST OF ILLUSTRATIONS

- 0.0** Photo of the LIFT house window
Photo by author
- 0.1** Diagram of the geographical location of Bangladesh
Drawn by author
- 1.0** Diagram of Bangladesh and surrounding countries
Drawn by author
- 1.1** Population density map of Bangladesh from 1961
Drawn by author
- 1.2** Population density map of Bangladesh from 1991
Drawn by author
- 1.3** Map of Bangladesh showing seismic hazard
Drawn by author
- 1.4** Map of Bangladesh showing groundwater depth
Drawn by author
- 1.5** Map indicating major cities and locations of slum settlements
Drawn by author
- 1.6** Map showing the networks of water bodies
Drawn by author
- 1.7** Bengali poetry and english translation by Mahmud
Poetry and translation from Mahmud, *River Life, Bangladesh*
- 1.8** Erosion of Padma River
Photo from Mahmud, *River Life, Bangladesh*
- 1.9** Temporary shelter on the banks of Dharala River
Photo from Mahmud, *River Life, Bangladesh*
- 1.10** Tourist Area in Mongla
Photo from Mahmud, *River Life, Bangladesh*
- 1.11** Sail boats in the Padma River
Photo from Mahmud, *River Life, Bangladesh*
- 1.12** Urban population of megacities from 1950 - 2015
Graph from State of the World, 2007
- 1.13** Population growth rate of megacities in 2005 and projected for 2005-2015
Graph from UN World Urbanization Prospects: 2003 Revision
- 1.14** Percentage of migrant households by types of acquaintances in the initial place of settlement
Graph from Afsar, *Rural-Urban Migration in Bangladesh*
- 1.15** Map of Dhaka showing expansion of the city from the year 1600 - 1950
Drawn by author
- 1.16** Map of Dhaka showing density in 2005
Drawn by author
- 1.17** Map of Dhaka showing projected density in 2015
Drawn by author
- 1.18** Map of Dhaka showing projected density in 2025
Drawn by author
- 2.0** Dhaka with surrounding rivers
Diagram by author
- 2.1** Table showing annual temperature, rainfall and time of flooding
Graph by author
- 2.2** Watershed characteristics of the Ganges and Brahmaputra/Meghna rivers compared with other big river systems of the world
Table from Hoffer & Messerli, *Floods in Bangladesh*
- 2.3** Estimated effects of the 1998 flood
Table from Hoffer & Messerli, *Floods in Bangladesh*
- 2.4** Map of Dhaka showing bastees and flood prone areas
Drawn by author
- 2.5** Rainfall in inches from 2003-2007
Drawn by author
- 2.6** A comparison of rain and flood periods in Bangladesh for eight flood years and two dry years (1923, 1978)
Table from Hoffer & Messerli, *Floods in Bangladesh*
- 2.7** Flood affected areas in Bangladesh over 40 years
Table from Hoffer & Messerli, *Floods in Bangladesh*
- 2.8** Map of Bangladesh showing affected areas in the 1974 flood
Map from Hoffer & Messerli, *Floods in Bangladesh*
- 2.9** Map of Bangladesh showing affected areas in the 1988 flood
Map from Hoffer & Messerli, *Floods in Bangladesh*
- 2.10** Map of Bangladesh showing affected areas in the 1998 flood
Map from Hoffer & Messerli, *Floods in Bangladesh*
- 2.11** Photo of waterlogged Dhaka, 2009
Photo by author
- 2.12** Photo of a storekeeper draining water, Dhaka 2009
Photo provided by Centre for Urban Studies, Dhaka

- 3.0** Photo of Karail Baste
Photo by Dr. Peter Kim Streatfield
- 3.1** Use of space for home based businesses and the involvement of women in these activities were evaluated in three low income settlements
Table from Mahmud, *Cities*
- 3.2** Photo of women participating in activities for home based income
Photo from Marie Claire, "Tarango"
<http://www.marieclaire.com/cm/marieclaire/images/women%20of%20tarango-mc.jpg> (Accessed November 2010)
- 3.3** Reasons behind why women do not apply training knowledge
Table from Sharmeen & Parvin, *Architecture for the Economically Disadvantaged*
- 4.0** Photo of baste on bamboo stilts
Table from CUS, *Slums of Urban Bangladesh*
- 4.1** Distribution of bastees by population size in six major cities of Bangladesh
Table from CUS, *Slums of Urban Bangladesh*
- 4.2** Overall characteristics of baste settlements
Table from CUS, *Slums of Urban Bangladesh*
- 4.3** Perception of baste within the community in six cities
Table from CUS, *Slums of Urban Bangladesh*
- 4.4** Land ownership pattern in bastees by city
Table from CUS, *Slums of Urban Bangladesh*
- 4.5** Household monthly income pattern for six cities
Table from CUS, *Slums of Urban Bangladesh*
- 4.6** Tap water sharing patterns by city
Table from CUS, *Slums of Urban Bangladesh*
- 4.7** Tube well sharing patterns by city
Table from CUS, *Slums of Urban Bangladesh*
- 4.8** Sources of drinking water
Table from CUS, *Slums of Urban Bangladesh*
- 4.9** Access to electricity and cooking gas
Table from CUS, *Slums of Urban Bangladesh*
- 4.10** Household access to different types of latrines
Table from CUS, *Slums of Urban Bangladesh*
- 4.11** Household latrine sharing pattern
Table from CUS, *Slums of Urban Bangladesh*
- 4.12** Household access to garbage
Table from CUS, *Slums of Urban Bangladesh*
- 4.13** Household garbage collection pattern
Table from CUS, *Slums of Urban Bangladesh*
- 4.14** Size of house or room in bastees for six cities
Table from CUS, *Slums of Urban Bangladesh*
- 4.15** Percentage of slums covered by NGOs in six cities
Table from CUS, *Slums of Urban Bangladesh*
- 4.16** Drainage conditions in bastees of six cities
Table from CUS, *Slums of Urban Bangladesh*
- 4.17** Flooding in bastees of six cities
Table from CUS, *Slums of Urban Bangladesh*
- 4.18** Rental status of baste inhabitants in six cities
Table from CUS, *Slums of Urban Bangladesh*
- 4.19** Occupation of baste inhabitants in six cities
Table from CUS, *Slums of Urban Bangladesh*
- 4.20** Photo of village of New Gourna
Photo from Spatial Agency "Hassan Fathy", <http://www.spatialagency.net/database/how/subversion/hassan.fathy> (accessed October 2010)
- 4.21** Photo of a baste in Dhaka
Photo by author
- 5.0** Photo of the Maasbommel harbour
Photo provided by Chris Zevenbergen
- 5.1** Sections of the Maasbommel amphibious house on ground and on water
Drawing from Dura Vermeer, "Amphibious and Floating Homes in Maasbommel,"
http://www.duravermeerbusinessdevelopment.nl/uk/project_info.asp?id=579 (accessed September 2009)
- 5.2** Amphibious house in Maasbommel, Netherlands
Photo provided by Chris Zevenbergen
- 5.3** Amphibious house in Maasbommel, Netherlands
Photo provided by Chris Zevenbergen
- 5.4** Reinforcement for the amphibious foundation
Photo by Hans Van Beek
- 5.5** Connection of two buoyant foundations to the steel mooring poles
Photo provided by Chris Zevenbergen
- 5.6** Concrete foundations, poles and flexible plumbing connections
Photo provided by Chris Zevenbergen
- 5.7** Ground floor completed of the amphibious houses
Photo provided by Chris Zevenbergen

- 5.8** The two houses sit on a shared platform that allow the houses to float together
Photo provided by Chris Zevenbergen
- 5.9** Roof installment on amphibious houses
Photo provided by Chris Zevenbergen
- 5.10** Vertical guidance system for the LSU prototype
Photo by Gerry Masterman
- 5.11** LSU prototype demonstrating floatation of amphibious structure
Photo by Jill Bambury
- 5.12** A house floating on empty drums in Halong Bay, Vietnam
Photo from PBase, "Halong Bay - Floating Village"
<http://www.pbase.com/avismar/image/81707868/large>
(Accessed October 2010)
- 5.13** Floating houses in Agusan Marsh, Philippines
Photo from Philippines birding trip reports,
<http://philippinebirdtrips.blogspot.com/2009/02/agusan-marsh-agusan-del-sur-mindanao.html>
- 5.14** Floating houses on empty drums in Chong Kneas, Cambodia
Photo from Photo Stauk, "Chong Kneas floating village on Tonle Sap Lake, Cambodia"
<http://www.photostaud.com/asia/cambodia/tonle-sap-lake/3882-floating-village-on-tonle-sap-lake-cambodia.html> (Accessed October 2010)
- 5.15** Front veranda used for daily activities
Photo from Holiday in Ankor Wat, "Cleaning a coconut by the lake" <http://www.holiday-in-angkor-wat.com/tonle-sap-chong-kneas.html> (Accessed October 2010)
- 6.0** Flag of Bangladesh
Image from Flickr "Bangladeshi Flag",
<http://www.flickr.com/photos/sami5001/2627719375/>
(Accessed October 2010)
- 6.1** A resident of a bamboo house on stilts is drying rice on the balcony
Photo by M. Atikur Rahman and M. A. Taher from *Adibashi Shampradoy*
- 6.2** Bamboo pavilion of Expo 2000 in Hanover
Photo from Velez, *Grow Your Own House*
- 6.3** The LIFT house static on ground during dry season
Illustration by author
- 6.4** The LIFT house floating on water during floods
Illustration by author
- 6.5** Rendering of the LIFT community
Illustration by author
- 6.6** Ground floor plan of a LIFT community
Illustration by author
- 6.7** Interior courtyard of a LIFT community
Illustration by author
- 6.8** Amphibious houses floating in a LIFT community during a flood
Illustration by author
- 6.9** Model of a LIFT house with two dwellings
Illustration by author
- 7.0** Satellite image of HBRI indicating LIFT house site location
Image from Google Earth, accessed October 2010
- 7.1** Perimeter brick wall under construction
Photo by author
- 7.2** Service spine under construction with two horizontal lintel bands
Photo by author
- 7.3** Diagram of the rainwater harvesting and storage systems
Illustration by author
- 7.4** Diagram of the composting latrine system
Illustration by author
- 7.5** Plan showing locations of water harvesting and composting latrine systems
Illustration by author
- 7.6** Effectiveness of household water treatment systems
Table by Brian Skinner and Rod Shaw
- 7.7** Diagram of the solar energy system in each dwelling of the LIFT House
Illustration by author
- 7.8** Photovoltaic panel installed on a thatched roof in rural Bangladesh
Photo by Nafizur Rahman
- 7.9** Diagram of a bio gas fixed dome
Illustration provided by Dyutee
- 7.10** Photo of the top of a bio gas plant
Photo by Nafizur Rahman
- 7.11** Traditional wood burning stove with low heat efficiency
Photo by M. Atiyar Rahman and M. A. Taher, *Adibashi Shampradoy*

- 7.12** Improved stove with an exhaust chimney
Photo provided by Dyutee
- 7.13** Prefabricated bamboo columns for the LIFT house
Photo by author
- 7.14** Peeled bamboo skins
Photo by author
- 7.15** Sample top layer of bamboo roof
Photo by author
- 7.16** Calculations for the depth of the ferrocement foundation
Table by author
- 7.17** Calculations for the depth of the water bottle foundation
Table by author
- 7.18** A corrugated tin house in Karail basteer
Photo by author
- 7.19** Dwellings on stilts in Raiyer Bazaar basteer
Photo by author
- 7.20** Bamboo dwelling on stilts beside a water body
Photo by author

- 8.0** Soil test being conducted on the site of the LIFT house
Photo by author
- 8.1** Excavation for the LIFT house service spine
Photo by author
- 8.2** Ground Floor Plan
Drawing by author
- 8.3** Second Floor Plan
Drawing by author
- 8.4** Foundation Layout in Service Spine
Drawing by author
- 8.5** Plan of top concrete slab in Service Spine
Drawing by author
- 8.6** Lintel layout plan for Service Spine
Drawing by author
- 8.7** Column and lintel details
Drawing by author
- 8.8** Typical concrete column sections
Drawing by author
- 8.9** Sections A and B
Drawing by author
- 8.10** Section C
Drawing by author

- 8.11** Section D
Drawing by author
- 8.12** Side Elevation
Drawing by author
- 8.13** Front Elevation
Drawing by author
- 8.14** Beginning of excavation
Photo by Kalyani Sudhir
- 8.15** Workers struggling to pump water out of the excavated area
Photo by author
- 8.16** Workers excavating the site manually
Photo by author
- 8.17** Excavators using bamboo baskets to move the soil
Photo by author
- 8.18** Water being pumped out of the excavated area
Photo by author
- 8.19** Excavators faced difficulty in continuing work with the slippery soil
Photo by author
- 8.20** Shutters placed around the perimeter in preparation for concrete pour
Photo by author
- 8.21** Brick soiling prepared for concrete slab
Photo by author
- 8.22** Cement bags delivered in small amounts to avoid storage on site
Photo by author
- 8.23** Reinforcing bars prepared for concrete slab
Photo by author
- 8.24** Reinforcement laid for concrete slab
Photo by author
- 8.25** HBRI's concrete mixture used to pour floor slab of the service spine
Photo by author
- 8.26** Panoramic photo of LIFT site with reinforcement bars for columns
Photo by author
- 8.27** Worker pouring service spine floor slab
Photo by author
- 8.28** 15" perimeter wall with dowels for added strength
Photo by author

- 8.29** Walls of the service spine around the composting latrine storage pits
Photo by author
- 8.30** Concrete poured into gaps left for columns in the brick walls of the service spine
Photo by author
- 8.31** Concrete lintels
Photo by author
- 8.32** Service spine walls and columns for water cisterns completed halfway
Photo by author
- 8.33** Preparation of the holding tank for bamboo treatment
Photo by author
- 8.34** The start of the foundation models for testing
Photo by Kalyani Sudhir
- 8.35** Water bottle foundation model
Photo by author
- 8.36** Volunteer attaching ropes to encase the used water bottles in preparation for testing
Photo by author
- 8.37** Workers testing the water bottle foundation model for live load capacity
Photo by author
- 8.38** Model tipping over
Photo by author
- 8.39** Second foundation model wrapped in metal wire and cotton cloth
Photo by author
- 8.40** Inspection of the second foundation model before testing
Photo by Kalyani Sudhir
- 8.41** Bamboo floor built for volunteers to be able to sit on model
Photo by author
- 8.42** Live load test showed greater capacity than the water bottle foundation in similar size
Photo by author
- 8.43** Bamboo delivery on a “Thelagari”, a vehicle made of bamboo, wood, and two tires pulled by two men
Photo by author
- 8.44** Bamboo drilled at every joint by a volunteer
Photo by Kalyani Sudhir
- 8.45** Bamboo cut by hand saws
Photo by author
- 8.46** Bamboo treated in the traditional method of submerging in a water body
Photo by author
- 8.47** Chemical treatment of the bamboo before installment
Photo by author
- 8.48** Worker bending dowels
Photo by author
- 8.49** Lintels for lateral support inside the water cisterns in the service spine
Photo by author
- 8.50** Shutters around the corner concrete columns in the service spine
Photo by author
- 8.51** Service spine
Photo by author
- 8.52** Ceramic bricks installed in the visible sections above the “Bangla” bricks
Photo by author
- 8.53** The LIFT house across the pond
Photo by author
- 8.54** Workers laying brick walls above the lintel band
Photo by author
- 8.55** Excavation of the holding tank for the ferrocement foundation dwelling
Photo by author
- 8.56** Excavation of the holding tank for the water bottle foundation dwelling
Photo by author
- 8.57** Layer of concrete on brick soiling on the bottom of the water bottle foundation dwelling holding tank
Photo by author
- 8.58** Side walls for water bottle foundation dwelling holding tank
Photo by author
- 8.59** Ferrocement foundation frame of steel rods and wire mesh
Photo by author
- 8.60** Ferrocement foundation structural frame
Photo by author
- 8.61** Ferrocement foundation placed into holding tank
Photo by author
- 8.62** Cement mixture poured into frame and compressed
Photo by author

- 8.63** Cement mixture laid on both the outside and inside face of the foundation
Photo by author
- 8.64** Shutters laid for concrete ribs
Photo by author
- 8.65** Bamboo being dried after treatment
Photo by author
- 8.66** Bamboo shaved to reveal smoother finish
Photo by author
- 8.67** Bamboo cut into usable pieces
Photo by author
- 8.68** Stick model of bamboo dwelling to communicate to bamboo workers
Photo by author
- 8.69** Bamboo roof sample
Photo by author
- 8.70** Bamboo weaving pattern sample
Photo by author
- 8.71** Bamboo placed in wood clamps to straighten the bamboo before joining
Photo by author
- 8.72** Method of creating beams
Photo by author
- 8.73** Metal wires tied around steel rod insertion in bamboo beams
Photo by author
- 8.74** Bamboo pre-drilled before inserting steel rod into columns
Photo by author
- 8.75** Grooves left in wall of the service spine to place vertical guidance tracks
Photo by author
- 8.76** Straightening the opening in the steel vertical guidance tracks
Photo by author
- 8.77** Bamboo pegs made for joints that will be exposed to water
Photo by author
- 8.78** First column pulled into place
Photo by author
- 8.79** Bamboo columns carried to position
Photo by author
- 8.80** Beams attached to columns by bamboo workers
Photo by author
- 8.81** Connection of bamboo beam and column
Photo by author
- 8.82** Nylon tied around bamboo connection
Photo by author
- 8.83** Structural frame for water bottle foundation dwelling
Photo by author
- 8.84** Detail of column and beam connection
Photo by author
- 8.85** Installment of top beams
Photo by author
- 8.86** Mulli bamboo split in thin strips for weaving
Photo by author
- 8.87** Special blade used to split Mulli bamboo in thin strips
Photo by author
- 8.88** Service spine finished and installment of first bamboo structure complete
Photo by author
- 8.89** Used water bottles prepared for foundation by volunteers
Photo by author
- 8.90** Jawa bamboo pieces layed in two layers for floors in dwelling
Photo by author
- 8.91** Bamboo frame with nylon net for water bottle foundation
Photo by author
- 8.92** Experiments with bamboo to use in various applications
Photo by author
- 8.93** Panoramic photo of the LIFT construction site
Photo by author
- 8.94** Ferrocement foundation moved into position after curing
Photo by author
- 8.95** Bamboo mats weaved for interior walls
Photo by author
- 8.96** Custom latrine made to divert urine
Photo by author
- 8.97** Underside of second floor
Photo by author
- 8.98** Installment of bamboo railings
Photo by author
- 8.99** Careful placement of bamboo column into ferrocement foundation
Photo by author

- 8.100** Beam placement in ferrocement foundation dwelling
Photo by author
- 8.101** Bamboo frame showing connections
Photo by author
- 8.102** Columns pulled in place on ferrocement foundation
Photo by author
- 8.103** Boundary wall for raised garden
Photo by author
- 8.104** View of LIFT house across the pond
Photo by author
- 8.105** Second bamboo frame under construction
Photo by author
- 8.106** Team lunch
Photo by author
- 8.107** Used water bottles inserted into foundation
Photo by author
- 8.108** Grout lines cleaned by workers
Photo by author
- 8.109** Water barrier placed on top of water bottle foundation
Photo by author
- 8.110** Water bottle foundation dwelling floating on water
Photo by author
- 8.111** Water bottle foundation dwelling in buoyant state
Photo by author
- 8.112** Buoyant dwelling tested with live load
Photo by Atyar Rahman
- 8.113** Bamboo frame with roof
Photo by author
- 8.114** Bamboo frame of second dwelling
Photo by author
- 8.115** Plumbing laid for drainage
Photo by author
- 8.116** Installment of interior bamboo wall
Photo by author
- 8.117** Jawa bamboo floor finish
Photo by author
- 8.118** Installment of walls
Photo by author
- 8.119** Mulli bamboo split for facade finish
Photo by author
- 8.120** Installment of floor joists in ferrocement foundation
Photo by author
- 8.121** Treatment of bamboo for facade finish
Photo by author
- 8.122** Bamboo used as a cup by worker
Photo by author
- 8.123** Mr. Khan's visit to the LIFT site
Photo by Shahid Mohammed
- 8.124** Reporters on site
Photo by Shahid Mohammed
- 8.125** Installation of side wall finish
Photo by author
- 8.126** Installation of front wall finish
Photo by author
- 8.127** Dwelling on right floating on water pumped from the pond
Photo by author
- 8.128** Grameen Shakti installed improved stove
Photo by author
- 8.129** Finished bamboo railing on top slab of service spine
Photo by author
- 8.130** Front facade finish
Photo by author
- 8.131** Construction of front steps
Photo by author
- 8.132** Installation of Mulli bamboo strips as wall finish
Photo by author
- 8.133** Water seepage marks on the exterior of the cisterns
Photo by author
- 8.134** Interior stairs made of bamboo and wood
Photo by author
- 8.135** Installation of interior wall
Photo by author
- 8.136** Bamboo frame for kitchen on top of service spine
Photo by author
- 8.137** Installation of side walls
Photo by author
- 8.138** Interior of bamboo dwelling
Photo by author
- 8.139** Shared exterior space on top of service spine
Photo by author
- 8.140** Railings being secured
Photo by author
- 8.141** Raised Garden
Photo by author

- 8.142** Sliding window shutters being prepared by bamboo weavers
Photo by author
- 8.143** Wood door frame covered with bamboo cladding
Photo by Shahid Mohammed
- 8.144** Interior “bhelki”
Photo by author
- 8.145** Installation of toilet roof
Photo by author
- 8.146** LIFT house complete
Photo by author
- 8.147** Steel plate attaching dwelling to vertical guidance system
Photo by author
- 8.148** Installation of sliding shutters
Photo by author
- 8.149** Government officials at the inauguration
Photo by author
- 8.150** Speeches delivered at the inauguration
Photo by author
- 8.151** Signage on front facade of the LIFT house
Photo by author
- 8.152** Back facade of LIFT house from across the pond
Photo by author
- 8.153** Application of bamboo in many different finishes
Photo by author
- 8.154** LIFT house after inauguration
Photo by author
- 8.155** Construction sequence
Photo by author
- 8.156** Photo of bamboo workers and key team members in front of LIFT house
Photo by Shahid Mohammed
- 8.157** Press conference
Photo by Shahid Mohammed
- 8.158** Interviews with TV channels
Photo by Shahid Mohammed
- 8.159** Water source
Photo by author
- 8.160** Bathing and dishwashing area
Photo by author
- 8.161** Residents use the ground floor as a multipurpose room
Photo by author
- 8.162** Second floor of dwelling occupied by residents
Photo by author
- 8.163** Residents studying inside dwelling
Photo by author
- 8.164** Lal Mia planting vegetables in garden
Photo by author
- 8.165** Solar light fixture
Photo by author
- 8.166** Interior wall used to hang personal items
Photo by author
- 8.167** Furniture for storing belongings
Photo by author
- 8.168** Ferrocement foundation dwelling on ground (left) and buoyant on water (right)
Photo by author
- 9.0** The LIFT House with dwelling on the right floating on water
Photo by Biplob Kumar
- 9.1** Affordability options for future implementation of the LIFT House
Table by author
- 9.2** The LIFT community with 12 amphibious units
Site plan by author
- 9.3** Speculation on future implementation of LIFT communities in an existing slum settlement
Site plan by author
- 9.4** Speculation on future implementation of LIFT communities with 760 units
Site plan by author
- 9.5** Speculation on future implementation of LIFT communities with 1644 units
Site plan by author
- 9.6** (opposite) The LIFT House in October 2010
Photo by Biplob Kumar
- 9.7** (opposite) The LIFT House in October 2010
Photo by Biplob Kumar





0.0. (last page) Photo of the LIFT house window
0.1. Diagram of the geographical location of Bangladesh

INTRODUCTION

The motivation for this thesis came from my personal experiences in the inhabitable floods of Bangladesh. I was born and lived in Dhaka, Bangladesh for the first nine years of my life, where I encountered the great flood of 1988 that engulfed 60% of the country and crippled most of Dhaka. It was then I realized the power of floods. Unlike what many assume, floods bring more than just water into the city. Floods wash away homes, people, and their belongings. They are an indescribable force that takes over a city bringing it to an immediate halt. I was imprisoned in my third floor apartment while my family used boats to travel for necessities. Though I only noticed my own discomforts during that time, I later understood the incredible hardships the low income families had to bear as they struggled to rebuild their lives after the flood of 1988.

Nineteen years later I was in Miami volunteering at a Gala Dinner with Dr. Mohammed Yunus, the guest of honour. I only knew him as the Bangladeshi Nobel Peace Prize laureate before that event. After his speech I was deeply inspired to undertake and write a thesis that offered a solution that would make a difference in Bangladesh. Dr. Yunus gave me a reason to believe that even the largest of problems can be solved with small steps in the right direction. Microfinance was his concept that spread throughout the world as a tool for the poor to escape their financial hardships. I wanted to design a shelter for the poor as a tool that could help them in their future. I wanted to design a safe, flood-resilient house that would provide basic amenities, eliminating the rebuilding process after a flood and resulting in a healthier and more economically stable family. The design will need to fulfill the following:

- 1) Safety of life and protection of property in floods
- 2) Increase wellbeing of the inhabitants
- 3) Affordability for the urban poor of Bangladesh
- 4) Allow resident participation in the construction process
- 5) Promote income generation



CHINA

NEPAL

BHUTAN

INDIA

INDIA

BURMA

BAY OF BENGAL

CHAPTER 1.0

ON LAND

In 1971, the independent country of Bangladesh was established with dreams and goals of becoming a prosperous country with freedom and equality for its citizens. Its countrymen shed blood to free the country from the grips of Pakistan. Nearly 40 years later the country is held hostage to a different set of enemies: poverty and floods. Bangladesh has an important place in geography, surrounded by India on all sides and with close proximity to China (Fig. 1.0). Commerce is heavily dependant on the strong economies of these two neighbouring countries. The population is divided into two, the rich and the poor. With vast inequality between these groups, the urban centres of the country are struggling to provide basic services to the poor. The 147, 570 sq.km. of mostly low, flat land is densely populated by 123.1 million people, highly concentrated in the urban centres.¹ Figures 1.1-1.6 illustrate population density, seismic hazard, groundwater depths, slum locations and water body systems of Bangladesh. A network of rivers meanders through the fertile land draining large amounts of water from the Himalayas, and neighbouring countries, to the Bay of Bengal. A delta country known through the international media for its floods, Bangladesh has both a positive and negative relationship with water. Historically, water has been the primary mode of communication with the rest of the world. It has been the mode of transportation for importing and exporting goods. It is an essential lifeline of the country, an element without which Bangladesh cannot survive. Yet, the country needs to drain water from an area 12 times its own size, where 60% of the land is only 6 metres above sea level.² This stress on the river systems, along with other environmental effects and human activities, causes

1 Thomas Hofer and Bruno Messeri, *Floods in Bangladesh - History and Dynamics and Rethinking the Role of the Himalayas*. (New York: United Nations University, 2006), 11

2 *ibid*, 11

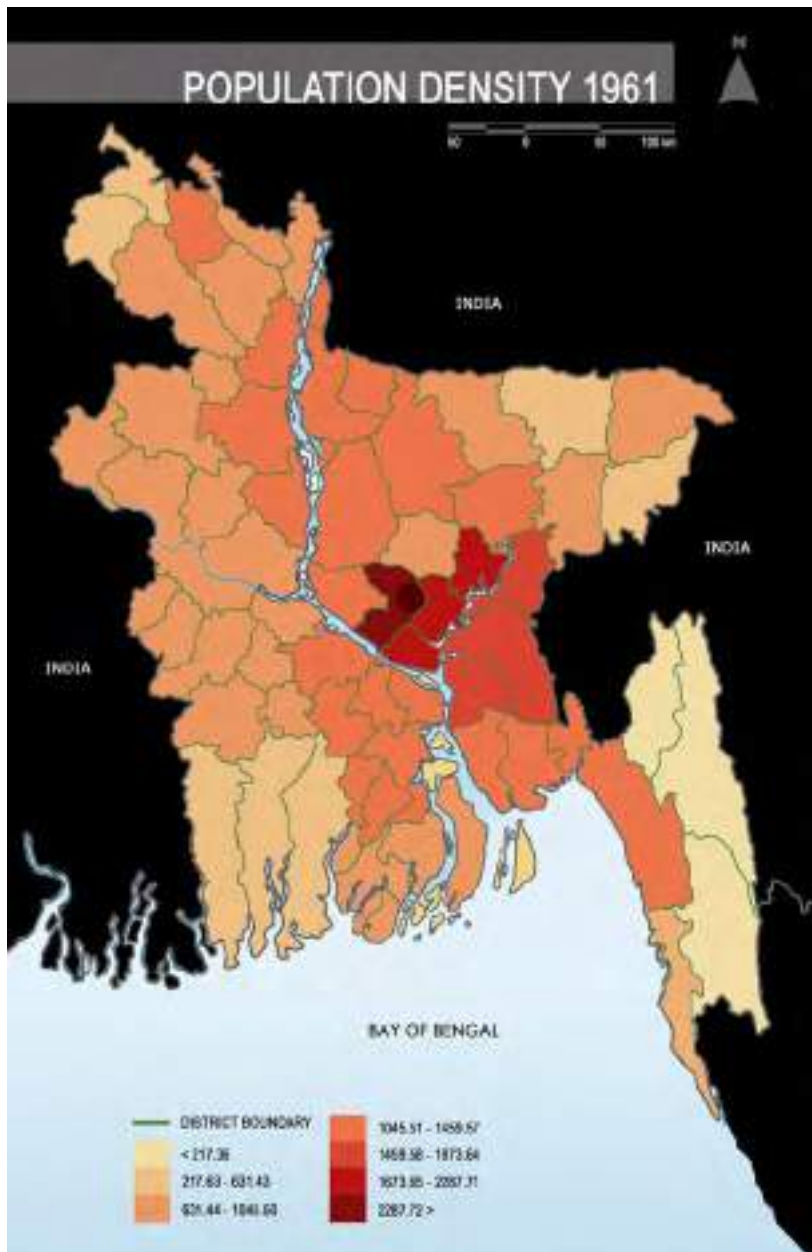

1.1. Population density map of Bangladesh from 1961

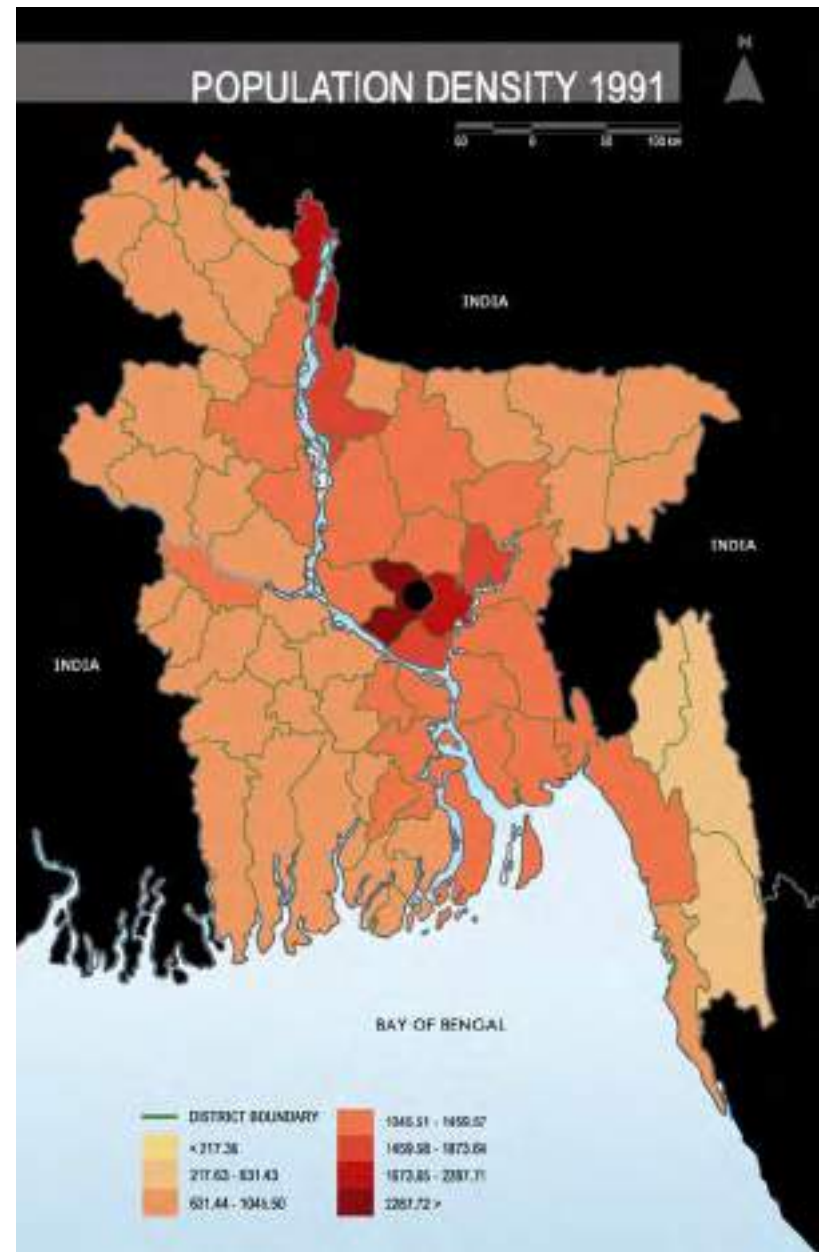

1.2. Population density map of Bangladesh from 1991

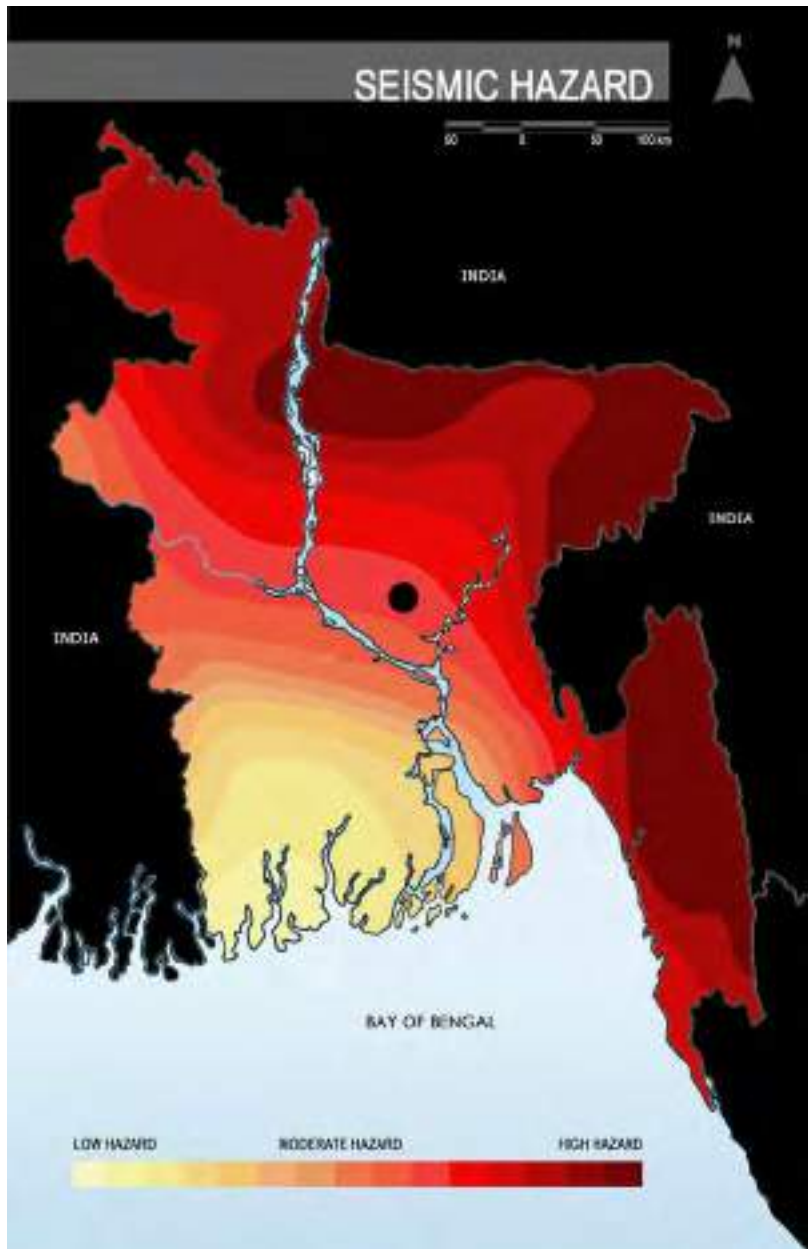

1.3. Map of Bangladesh showing seismic hazard

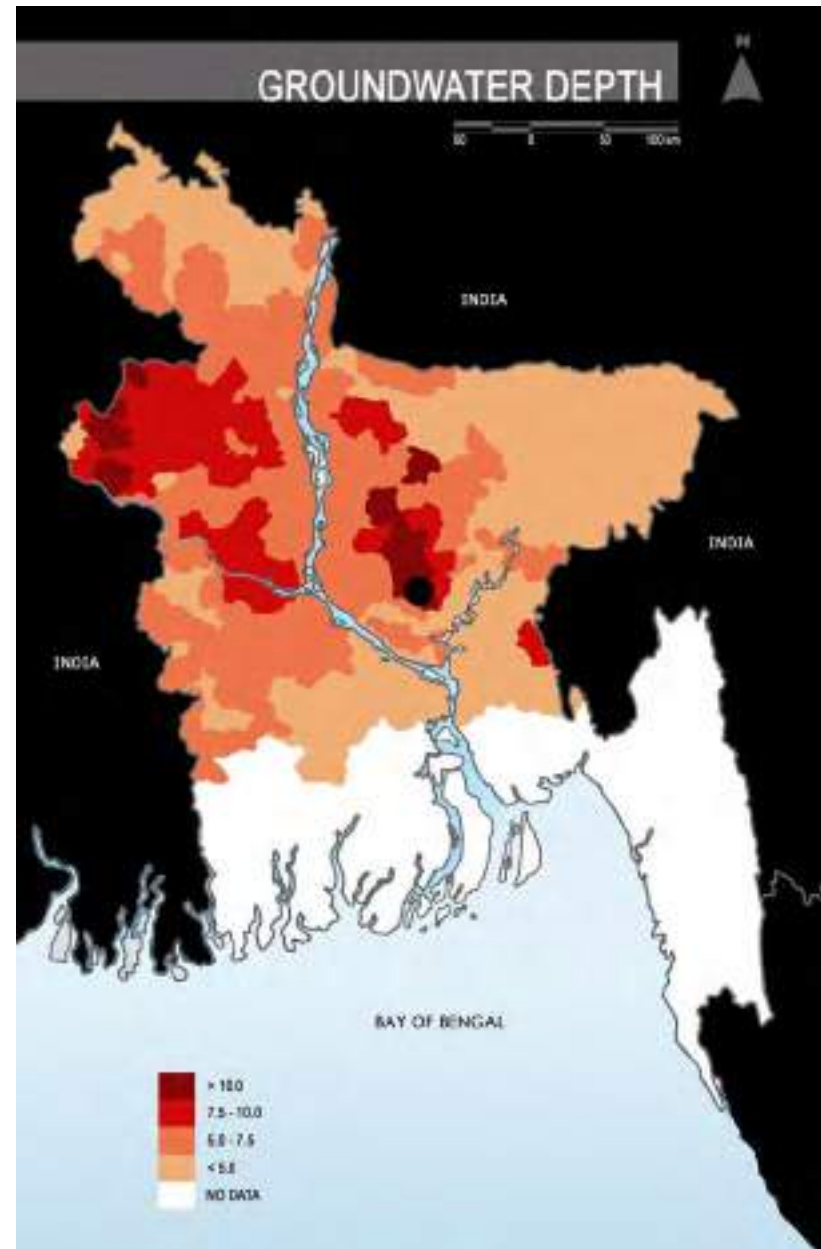

1.4. Map of Bangladesh showing groundwater depth

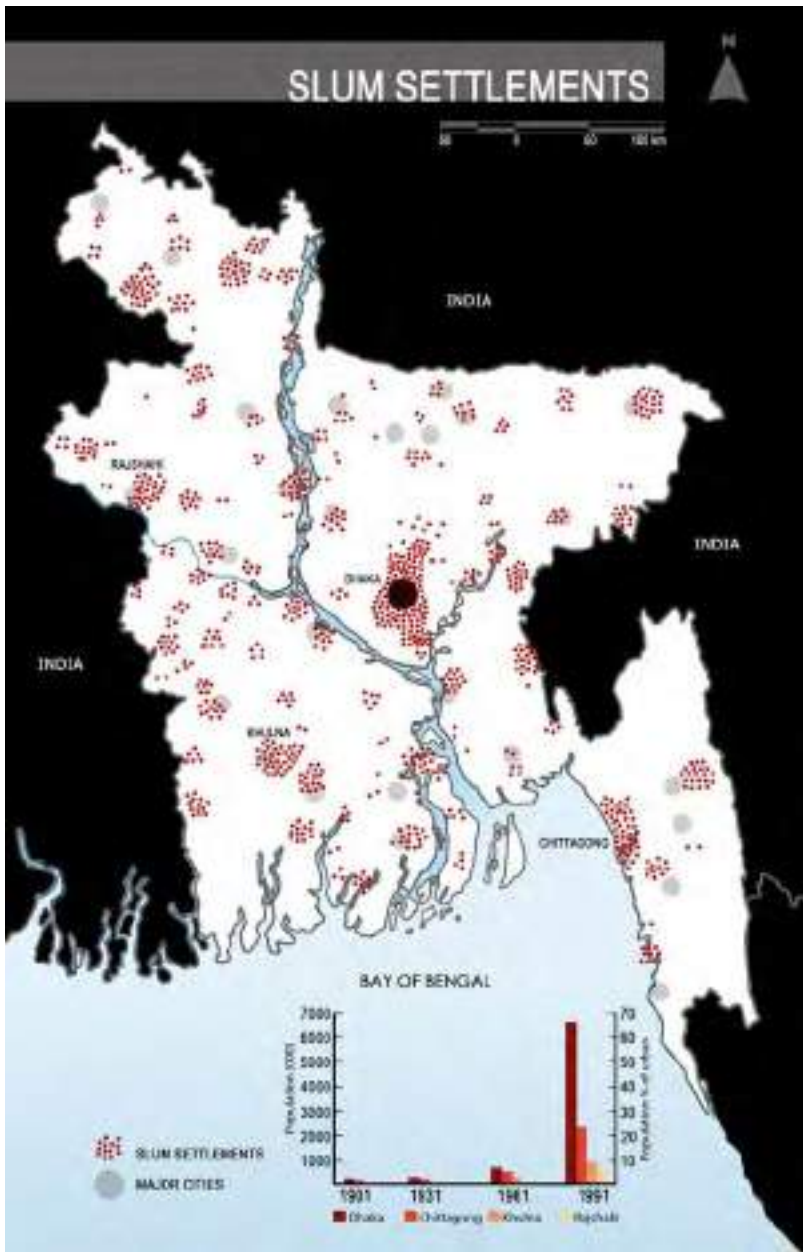

1.5. Map indicating major cities and locations of slum settlements



1.6. Map showing the networks of water bodies

catastrophic floods throughout the country, washing away lives, infrastructure, belongings, homes, and dreams.

Water is an overpowering element in the landscape of Bangladesh. It erodes and shapes the land every season. River banks are devoured and washed away, and new land is created somewhere else. The homeless follow the path of the water in search of newly created river banks. As they wage war for this new found land, they wait in fear of the next monsoon to see if the banks will remain (Fig. 1.7-1.9).

The monsoon rains wash the lands every year with great intensity. This is an expected event in the people’s lives, and they prepare for its arrival. This cyclic nature of water has become an important part of life for every citizen. As a result of the monsoon season and the excess water from the river beds, the land is flooded every year. Bangladeshi farmers acknowledge this seasonal flooding and make accommodations for it in their farming practices. Low levels of inundation are now a desired condition for crop growth.

Colourful boats dot the water passages of every village (Fig. 1.10-1.11). Large riverboats are overcrowd the water passages during the wet season and shallow wooden boats are used in the dry season. Given the catastrophic floods of the past, the river appears to be a dangerous zone for living. However, the perception in the minds of the Bangladeshi people is that the rivers are a blessing. Still the primary mode of transportation for the majority of people, the river remains the soul of the country.

Island of a Happy Home

নদী বলে চলে উত্তর থেকে দক্ষিণের সপ্তাহে
 কল্যাণ আসে গ্রাম, সব জেগে ওঠে অসাব-
 ধসলের খপ্পে নিমগ্ন হয় মাটি আর কল্যাণের মানুষ
 ভরে মানুষ
 কাশমন বেড়ে ওঠে, হঠাৎ তিব্বতের শালিখ পাখি ওঠে ।
 মেঘের সাথে সাথী হতে মনপননের আলোবাসায় মাঝে ধরা নৌকা আসে
 হসিন পালে
 লাল - হলুদ - নীল - সবুজ খপ্পে
 নদী বামধোয়ালী, আপন ইচ্ছায় দির কল্যাণ
 ভাঙে পাড়
 বসতবাড়ি
 সুখের বাগান
 আর ফসলের মাঠে বেখে যায়
 বলিমাটি নতুন জীবনের আশার সঙ্ঘবন্দা ।
 বহুতা নদীর কাছে না গেলে এদেশকে ক্রমা যাবে না ।

River flows from the north to the south, melts into the sea
 on its way, villages submerge
 soft new land forms again
 with a dream of a good harvest
 mud smeared
 water drenched islander dreams once again of a good harvest
 Sun grasses grow to their full length, tall and shiny
 mynah birds scream
 piercing the silence of a perfect late afternoon
 Companions of clouds, lovers of the wind
 colourful fishing boats set sail in dreams of
 red, yellow, blue and green
 River, hopelessly unpredictable, changes direction
 river banks erode
 devours happy homes
 gardens, and crop fields
 Leaves behind alluvial soil
 mark of an endless new beginning
 To know this land of ours, to feel the rhythm of the water
 one has to go to the river

- 1.7. Bengali poetry and english translation by Mahmud
- 1.8. (next page left) Eroding Padma River
- 1.9. (next page right) Temporary shelter on the banks of Dharala River









1.10. (last page left) Tourist area in Mongla

1.11. (last page right) Sail boats in the Padma River

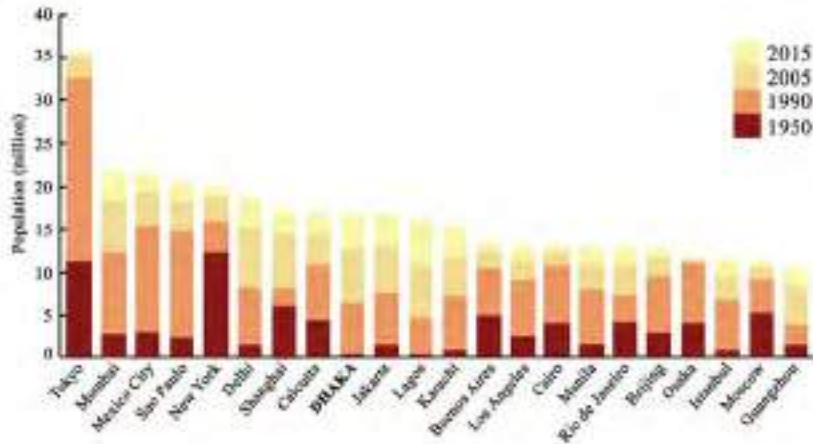

1.12. Urban population of megacities from 1950 - 2015



1.13. Population growth rate of megacities in 2005 and projected for 2005-2015

DHAKA

Dhaka, the capital city of Bangladesh, was established in 1608 on the banks of the Buriganga River by the Mughal Emperor Jahangir. Following the course of the Buriganga River, the Pre-Mughal city grew and expanded its borders into the Mughal Period (1604-1764). The British Period between 1764-1947 was witness to the city shrinking as it lost political power to Calcutta, now a city in India. In 1947, the new country of Pakistan was created after India became independent of British rule. During this time, Dhaka experienced a sudden population growth in its new role as the provincial capital. Rice paddies were quickly urbanized to cope with this sudden demand for infrastructure and a greater interest was taken into developing roads and city planning in the next decade.¹

In 1971, Bangladesh became an independent state with Dhaka as its capital. Since then it has been the fastest growing mega city in the world, with 25% of the population under the poverty line.² Figures 1.12 and 1.13 show the population growth of Dhaka. Due to rural-urban migration amongst other factors, the city of Dhaka has experienced rapid growth since 1971. In 2005, the population for the Dhaka Metropolitan Area (DMA) was 9.1 million.³ It is projected that by 2015, the DMA will be the ninth largest urban centre in the world.⁴

Approximately 21 million people have moved to the urban centres of the country between the beginning of the 20th century and 1991.⁵ Such large scale migration from the poorest

- 1 World Bank. *Building Safer Cities*. Edited by Alcira Kreimer et al. (Washington: The International Bank for Reconstruction and Development/The World Bank, 2003), 125
- 2 Dr. Qazi Azizul Mowla and Mohammed Sazzad Hossain. *AED - Architecture for the Economically Disadvantaged*. (Dhaka: Dept. of Arch., 2007), 8
- 3 Centre for Urban Studies (CUS) et al. *Slums in Urban Bangladesh*. (Dhaka: CUS, 2005), 18
- 4 The Worldwatch Institute. *State of the World - Our Urban Future*. (Washington: Norton & Company, 2007), 8
- 5 Rita Afsar. *Rural-Urban Migration in Bangladesh*. (Dhaka: The University Press Ltd., 2000), 30

areas of Bangladesh occurs in search of better employment, food, and security.⁶ Based on hearsay, people leave their homesteads in hope of a better life, only to find disappointment amid the slums of their dream city.⁷ Most migrate with little support, where some rely on their kinsmen as the support network in their new home (Fig. 1.14).⁸

The high density of Dhaka with over 34,670 people/sq.km. is a result of the scarcity of land with high elevations.⁹ Figures 1.15 shows the physical growth of the city and 1.16-1.18 illustrates density of Dhaka in 2005, 2015 and 2025. This topographical condition has led to the development of the city in a north-south pattern, rather than in a radial one. Most of the high lands that are protected from annual flooding are already developed. The remaining underdeveloped low lying lands become attractive to slum and squatter settlements. Floods remain life-threatening for occupants of these low lying lands and are a destructive force that impedes progress in the daily lives of the urban poor.

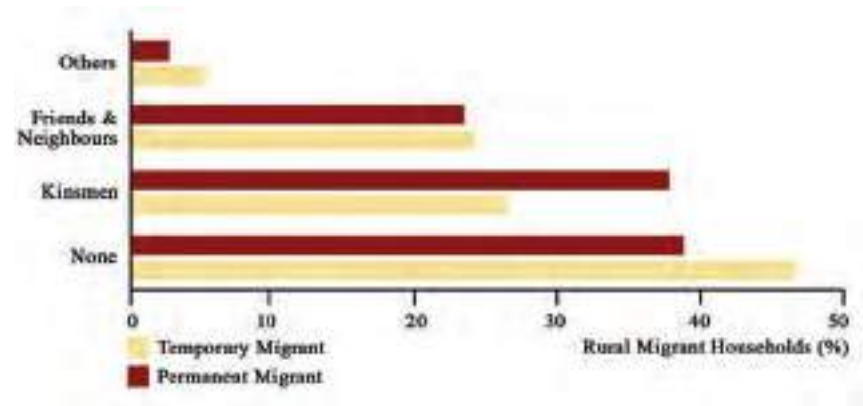

1.14. Percentage of migrant households by types of acquaintances in the initial place of settlement

6 AKM Ahsan Ullah et al. *Poverty and Migration - Slums of Dhaka, The Realities*, (Dhaka: ARDS, 1999), 25

7 *ibid*, 28

8 Rita Afsar. *Rural-Urban Migration in Bangladesh*, 58

9 Bangladesh Bureau of Statistics. *Statistical Yearbook of Bangladesh 2007*. Edited by Jafar Ahmed Chowdhury et al. (Dhaka: Bangladesh Bureau of Statistics, 2008), 37

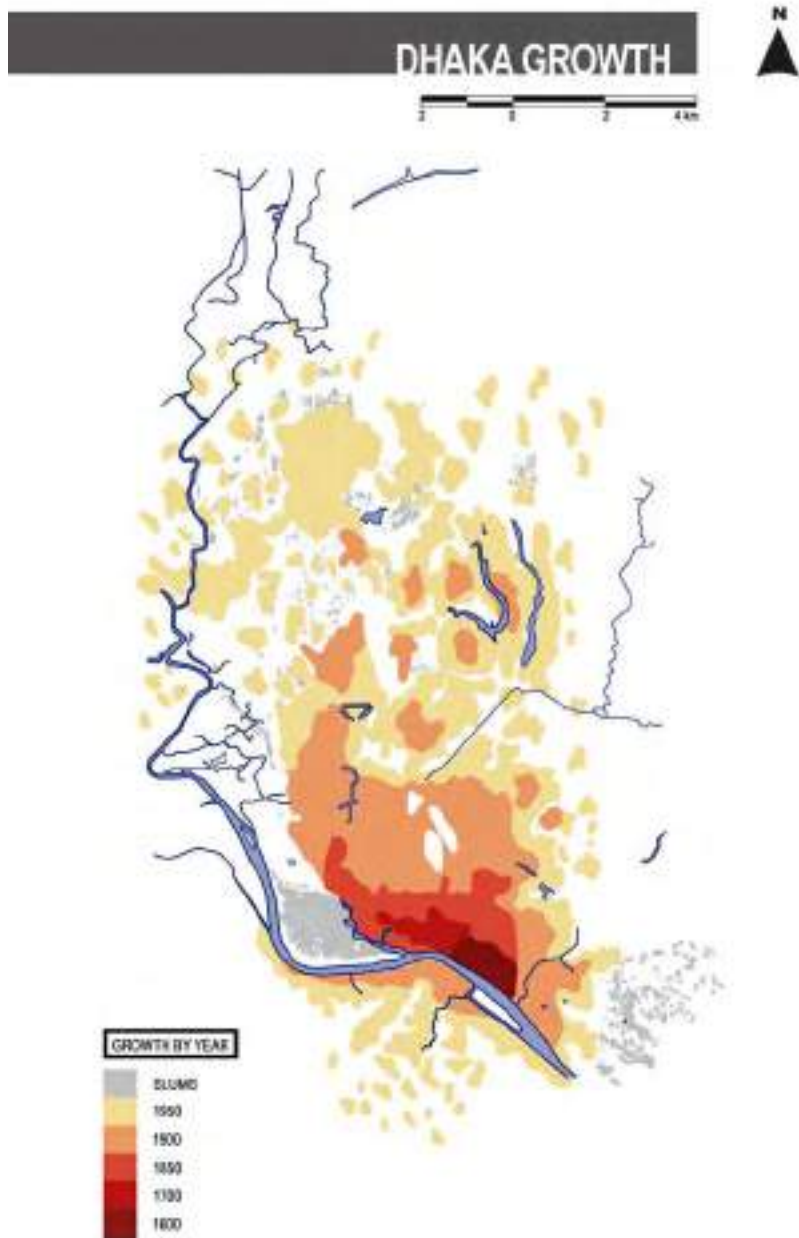

1.15. Map of Dhaka showing expansion of the city from the year 1600 - 1950

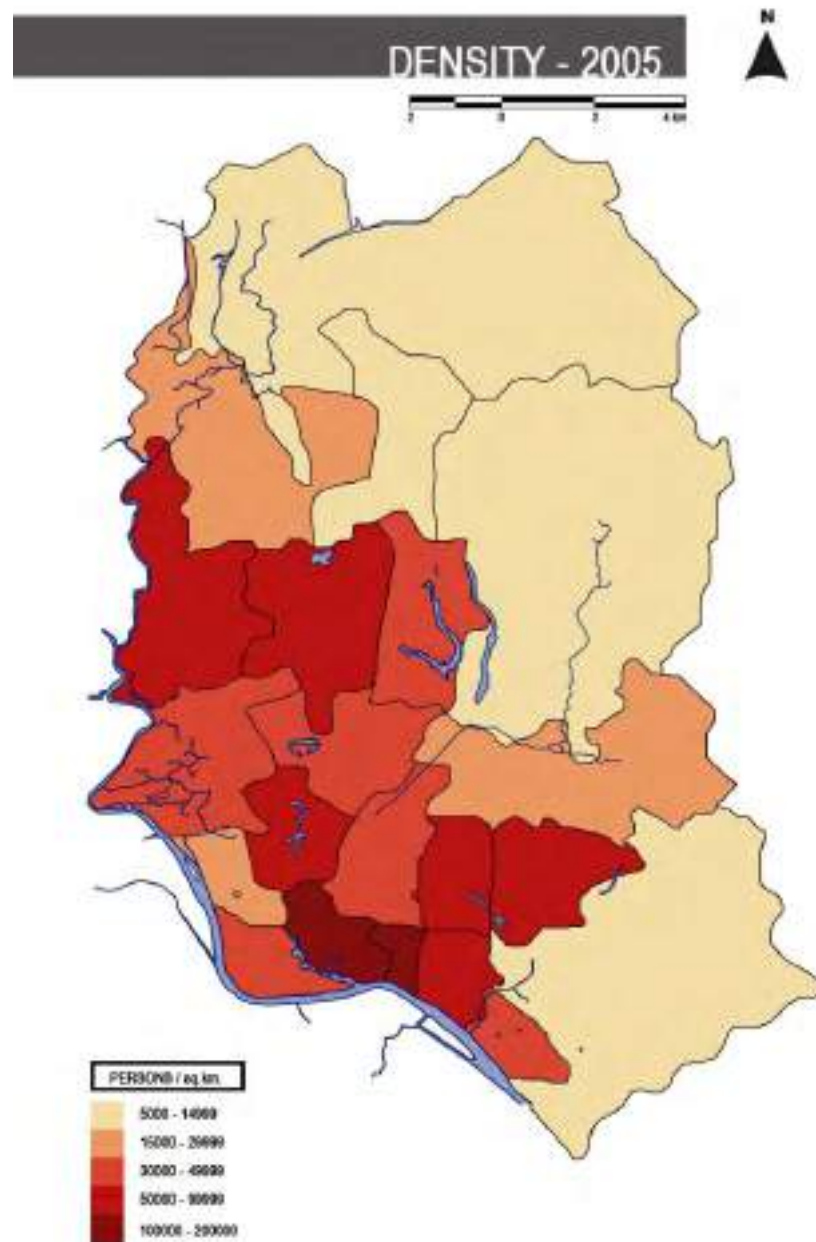

1.16. Map of Dhaka showing density in 2005

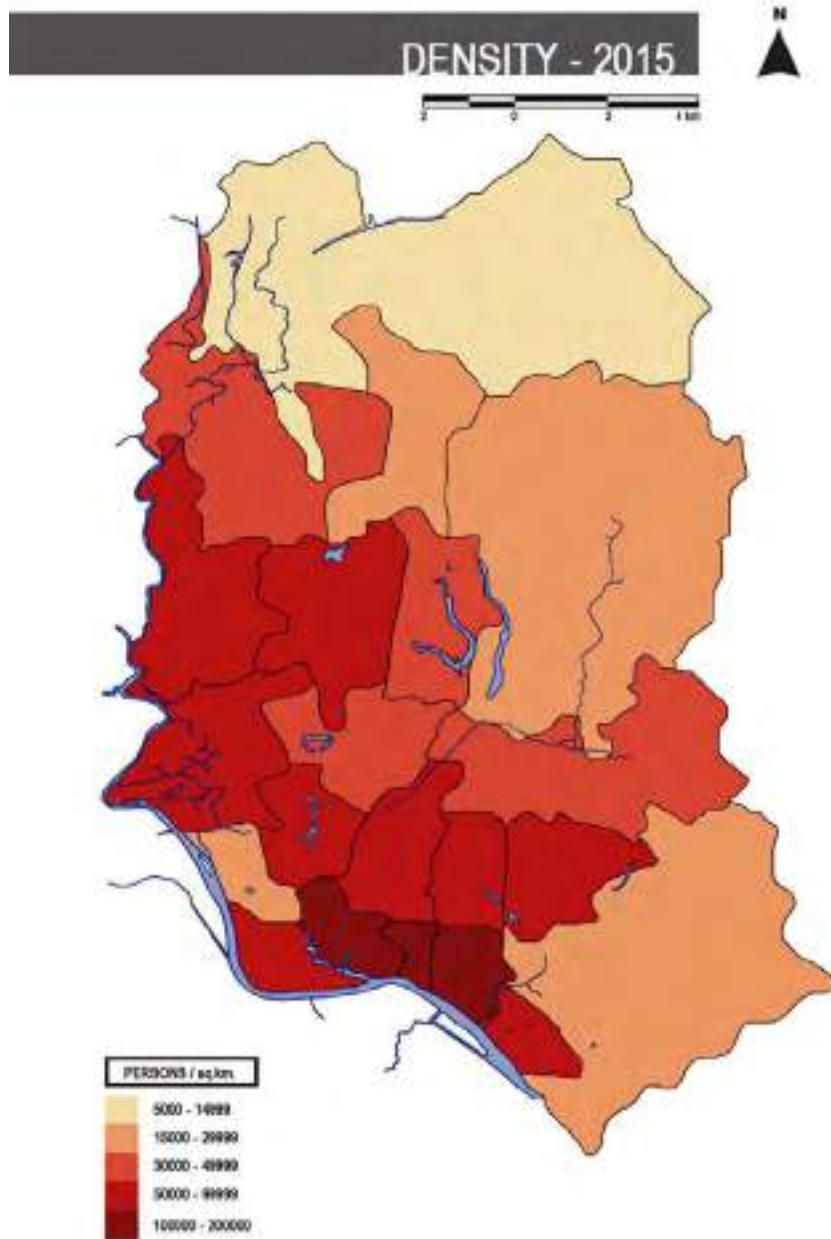

1.17. Map of Dhaka showing projected density in 2015

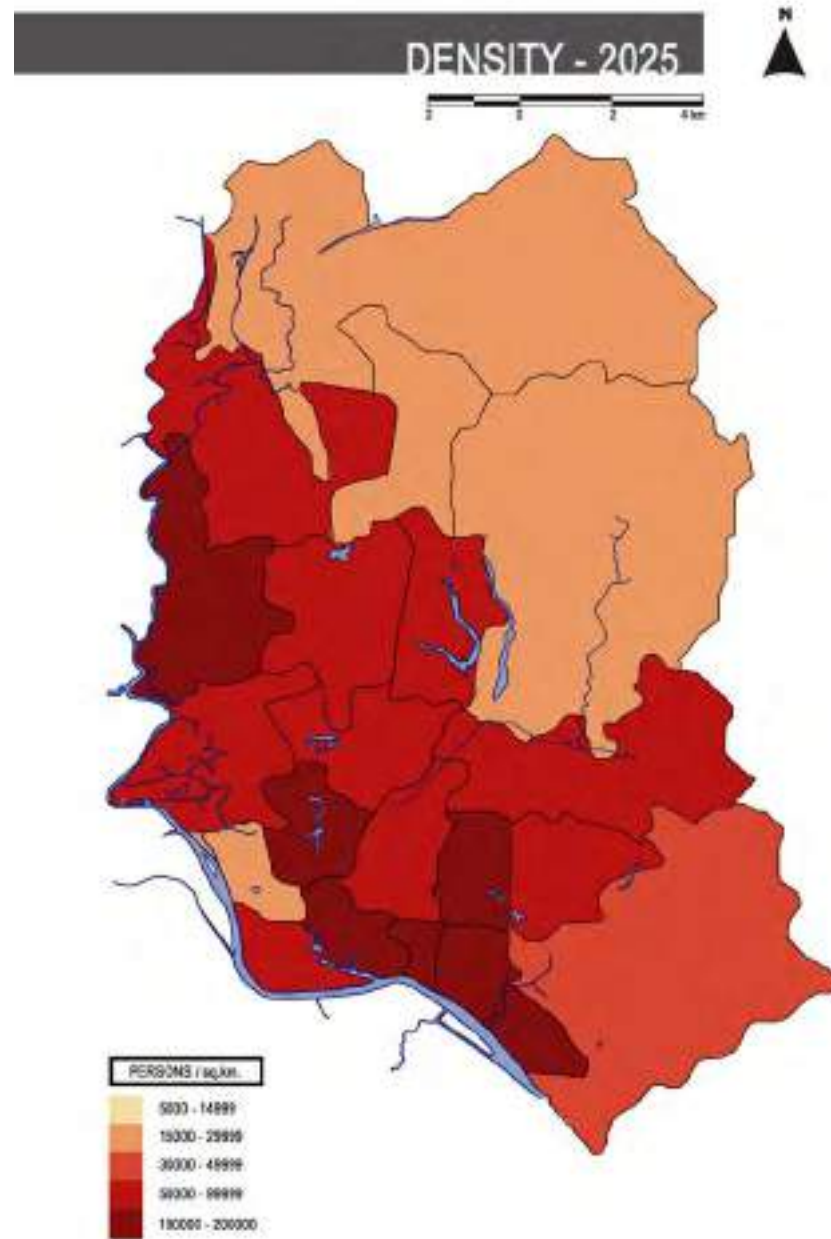

1.18. Map of Dhaka showing projected density in 2025

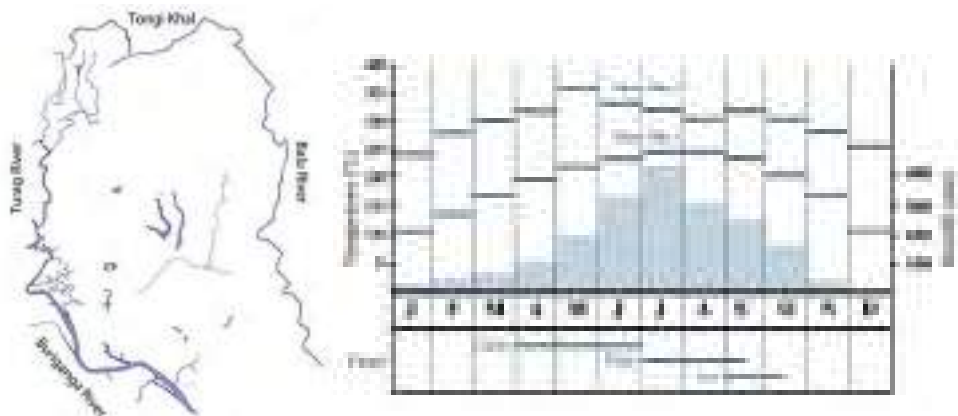

2.0. Dhaka with surrounding rivers

2.1. Table showing annual temperature, rainfall and time of flooding

Characteristics	Ganga	Brahmaputra/Meghna	Nile	Amazon	Mississippi	Kinross
Basin area (sq.km)	1,016,104	851,334	3,254,555	6,114,727	3,202,230	198,731
Length of river (mainstream km)	2,296	2,772	3,964	4,408	4,240	1,083
Average annual discharge (km ³ /year)	11,365	19,772	2,760	176,177	17,650	2,278
Population density (pp/50.km ²)	375	174	44	4	21	304
Forest (%)	4	19	2	73	22	7
Cropland (%)	71	29	10	15	35	64
Cropland irrigated (%)	15	47	5	0	4	0
Gasland (%)	7	29	52	8	22	0
Large dams	6	0	7	2	2,091	6

2.2. Watershed characteristics of the Ganges and Brahmaputra/Meghna rivers compared with other big river systems of the world

Number of people affected (different sources)	30,000,000; 31,648,746
Number of human deaths from flood related causes (different sources)	783; 1,050; 1,414; >1,500
Number of people facing malnutrition and disease	25 million
Roads and highways partially or completely damaged	15,000 km
Embankments partially or completely damaged (different sources)	4,451 km; 4,528 km
Number of bridges and culverts damaged	20,500
Number of villages damaged	30,500
Number of houses damaged (different sources)	550,000; 894,015
Number of educational institutions damaged	24,000
Number industrial units damaged	11,000
Number of tube wells damaged	300,000

2.3. Estimated effects of the 1998 flood¹

1 Thomas Hofer and Bruno Messerli, *Floods in Bangladesh - History and Dynamics and Rethinking the Role of the Himalayas*. (New York: United Nations University, 2003)

CHAPTER 2.0 ON WATER

Floods of different magnitude are a threat to nearly all the deltaic plains of the world, like the Bengal delta, the Mississippi River delta in the USA, the Yellow River in China, and the deltas of the Netherlands. Despite the dangers of living in these flood-prone low lands, the economic, cultural, and recreational opportunities in these areas are unparalleled.

Bangladesh is a country of rivers. It is a land rich in fertile soils due to silt deposits from seasonal flooding. This regular seasonal immersion of floodplains is well accommodated by people's settlements and economic activities.¹⁰ It is the abnormal inundation which occurs every 3-5 years that causes crop damage and catastrophic floods which occur every 10-20 years that cause overall extensive damages.¹¹ The country occupies the deltaic floodplains of two of the world's largest rivers, the Ganges and the Brahmaputra, with Dhaka situated in a floodplain surrounded by the distributaries of the Brahmaputra and the Meghna.¹² The surrounding rivers are Buriganga to the south, Turag to the west, Tongi khal to the north, and Balu to the east (Fig. 2.0). These rivers periodically flood the lowlands around the city.¹³

The elevation of Dhaka ranges from 2 to 13 meters above the mean sea level, and most of the urbanized areas lie within 6 to 8 meters.¹⁴ Severe floods in the city are mainly caused by overflow of surrounding rivers, as well as internal water-logging which occurs when water accumulates due to poor drainage.¹⁵

There are four types of floods in Bangladesh. River flooding occurs when river levels rise after the snow in the Himalayas melts and drains towards the Bay of Bengal. Local heavy rains increase the effects of this condition. Flash floods

10 Hugh Brammer. *Can Bangladesh be Protected from Floods?* (Dhaka: The University Press Limited, 2004), 3

11 ibid

12 ibid

13 Saleem Huq and Mozaharul Alam. *Flood Management and Vulnerability of Dhaka, Building Safer Cities*. (Dhaka: World Bank Publications, 2003), 121

14 ibid

15 ibid

occur when surrounding hilly areas receive heavy rainfall causing local rivers and streams to rise to a dangerous level. Urban flooding occurs due to drainage problems after heavy rains of 100mm or more. Tidal or storm surge floods are experienced in the coastline areas of the Bay of Bengal. Figure 2.1 shows Dhaka's annual temperature, rainfall and time of flooding.

The normal sequence of floods in Bangladesh starts with flash floods in the northern and eastern hill streams in the pre-monsoon period from April to May. Monsoon begins in June and continues until August, with the Ganges River peaking during August and September. This results in heavy flooding during these two months. Catastrophic floods occur when the Brahmaputra synchronizes with the peak of the Ganges. Figure 2.2 shows the characteristics of the Ganges and Brahmaputra rivers compared with other big rivers of the world.

In recent history, the city has experienced major floods due to the overflow of surrounding rivers in the following years: 1954, 1955, 1970, 1980, 1987, 1988, 1998 and 2004.¹⁶ Among these, the 1988 flood inundated 85% of the city with depths ranging from 1 - 14.8 feet, affecting 60% of the city dwellers.¹⁷ The flood devastated lives, destroyed personal property, economic achievements, and infrastructure. The first attempt to mitigate flood damage in Dhaka was started after the 1988 flood. The Buckland Flood Protection Embankment was a result of this and extends along the Buriganga River, protecting the western part of the city. Heavy rainfall over the catchment areas of the Ganges-Brahmaputra-Meghna river basin caused a flood in 1998. This was the most severe flood in duration and extent, inundating 56% of the city (Fig. 2.3).¹⁸ Figure 2.4 illustrates flood prone areas of Dhaka in relation to slum locations and infrastructure.

Heavy monsoon rainfall is another cause for floods and becomes a severe problem for certain areas of the city that are inundated for several days annually. The water depths in these areas reach 16-24 inches, creating infrastructural problems, economic losses, and disruptions to communication networks. Figure 2.5 shows amount of rainfall from 2003-2007 and Figure 2.6 illustrates a comparison between rain and flood periods in

16 ibid, 127
 17 ibid, 121
 18 ibid

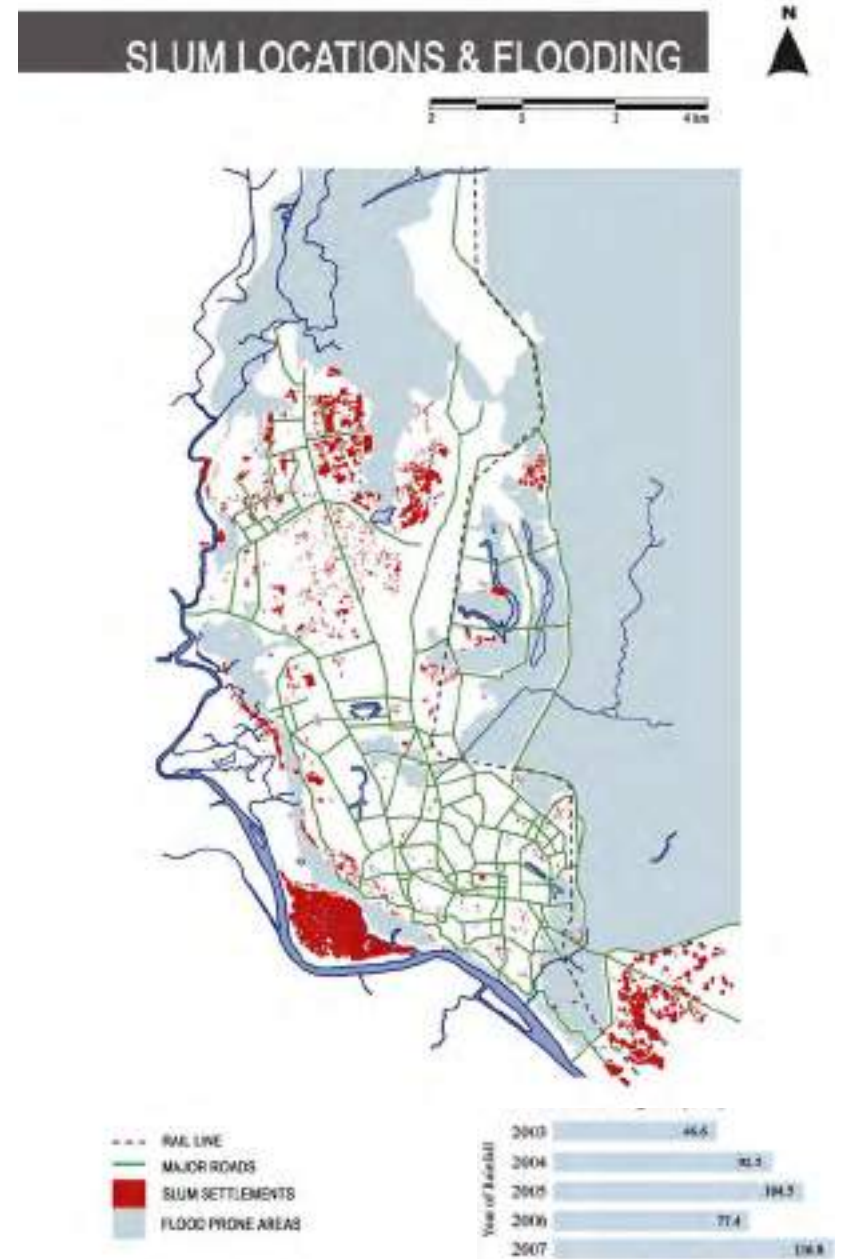

2.4. Map of Dhaka showing bastees and flood prone areas

2.5. Rainfall in inches from 2003-2007

Year		June	July	August	September
1966	Rainy Period				
	Flood Period				
1970	Rainy Period				
	Flood Period				
1972	Rainy Period				
	Flood Period				
1955	Rainy Period				
	Flood Period				
1974	Rainy Period				
	Flood Period				
1987	Rainy Period				
	Flood Period				
1988	Rainy Period				
	Flood Period				
1998	Rainy Period				
	Flood Period				
1923	Rainy Period				
1978	Rainy Period				

2.6. A comparison of rain and flood periods in Bangladesh for eight flood years and two dry years (1923, 1978)

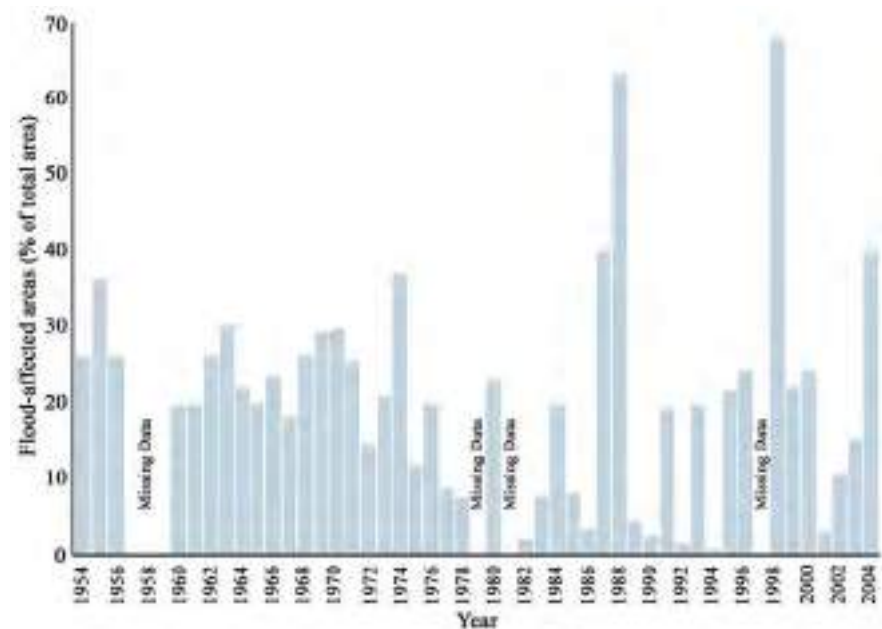

2.7. Flood affected areas in Bangladesh over 40 years

Bangladesh. Along with rising water levels, floods bring on a scarcity of clean drinking water and a variety of health problems and diseases for the low income population. More than ever, concerns for global warming have brought the issues of flood mitigation to the forefront for low lying areas around the world. A one-meter rise in sea level in Bangladesh will result in a loss of 17.5% of land area, effecting 13 million people.¹⁹ In its current state, the city is unable to adapt to the rising water levels from annual flooding. The added stress of rising sea level due to climate change will be catastrophic.

More than what happens during a flood, the aftermath has the most devastating effects on the livelihoods of the population. The consequences of flood damage are felt long after the water has receded. In 1974, thousands of people died in Bangladesh from a famine after a severe flood caused large scale crop damage. Survey findings of flood damages suggest that the burden of such damages affects the low income families of the city far more than the remaining population.²⁰ The poor suffer greatly due to loss of employment and damage to property, health, and housing. An analysis of flood damage indicated that the extent of damage and intensity of floods has increased since 1954 (Fig. 2.7).²¹ Figures 2.8-2.10 illustrate the increase in flood-affected areas from 1974 to 1998. Despite investments in large scale flood mitigation, such as the embankment placed on the western border of the city after the flood of 1988, damages continue to increase. Population growth and human activities in the catchments, such as urbanization, construction of roads, dams, and flood control embankments, etc. have increased the potential for flood hazards. The current master plan for the city of Dhaka indicates an alarming rate of urbanization that has spread throughout naturally low-lying areas. The areas once used as catchments are now raised in elevation to attract residents. This only puts the city at an increased risk of floods.

19 The Worldwatch Institute, *State of the World- Our Urban Future*. (Washington: Norton & Company Inc., 2007), 120

20 M. Shahjahan. *Flood Disaster Management in Deltaic Plain Integrated with Rural Development, Bangladesh Floods*. (Dhaka: The University Press Limited, 1998), 47

21 ibid

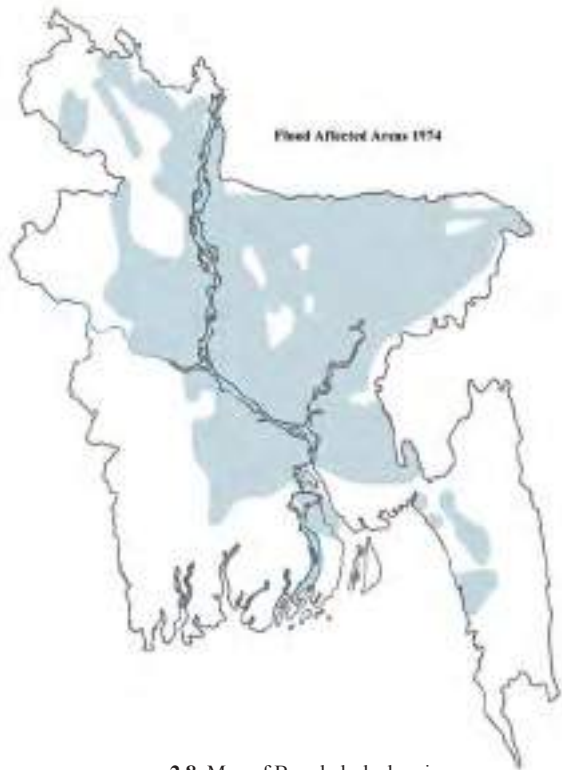

2.8. Map of Bangladesh showing affected areas in the 1974 flood

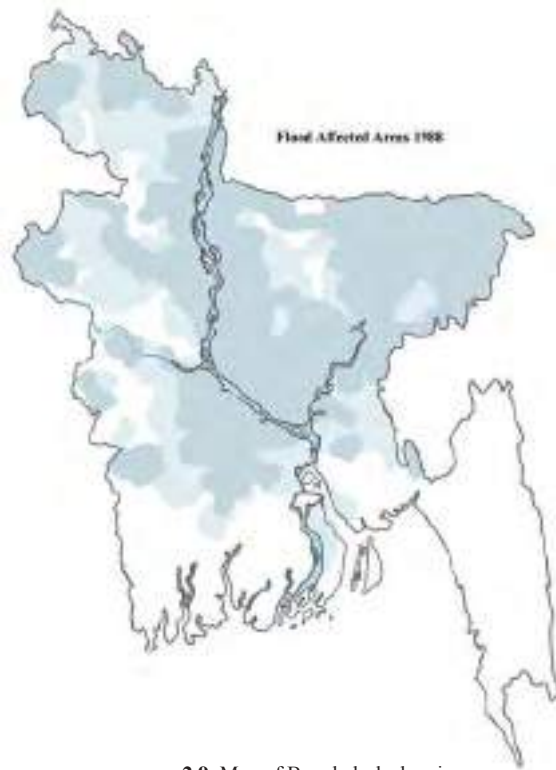

2.9. Map of Bangladesh showing affected areas in the 1988 flood

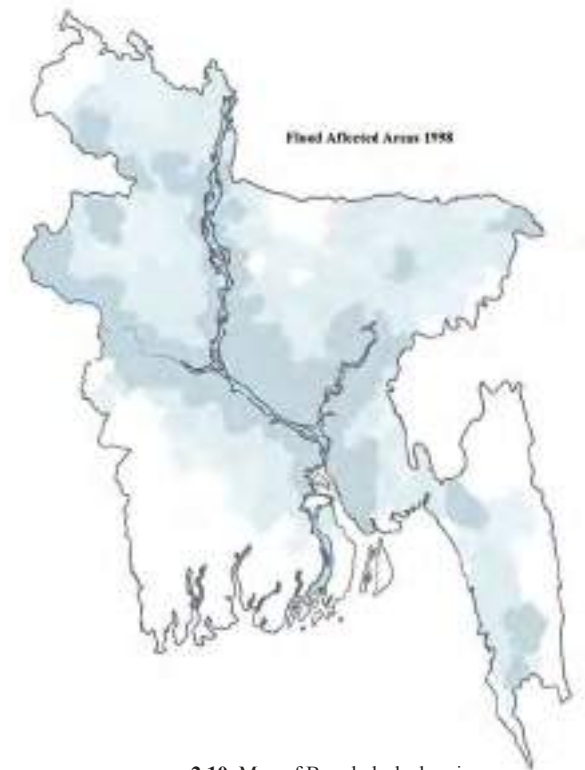

2.10. Map of Bangladesh showing affected areas in the 1998 flood





এখানে
টিভি
ভিসিডি
ক্যাসেট
ভাড়া
দেওয়া
হয়
ও
ক্যাফে
বিজি
হফ

2.11. (last page left) Photo of waterlogged Dhaka, 2009

2.12. (last page right) Photo of a storekeeper draining water, Dhaka 2009

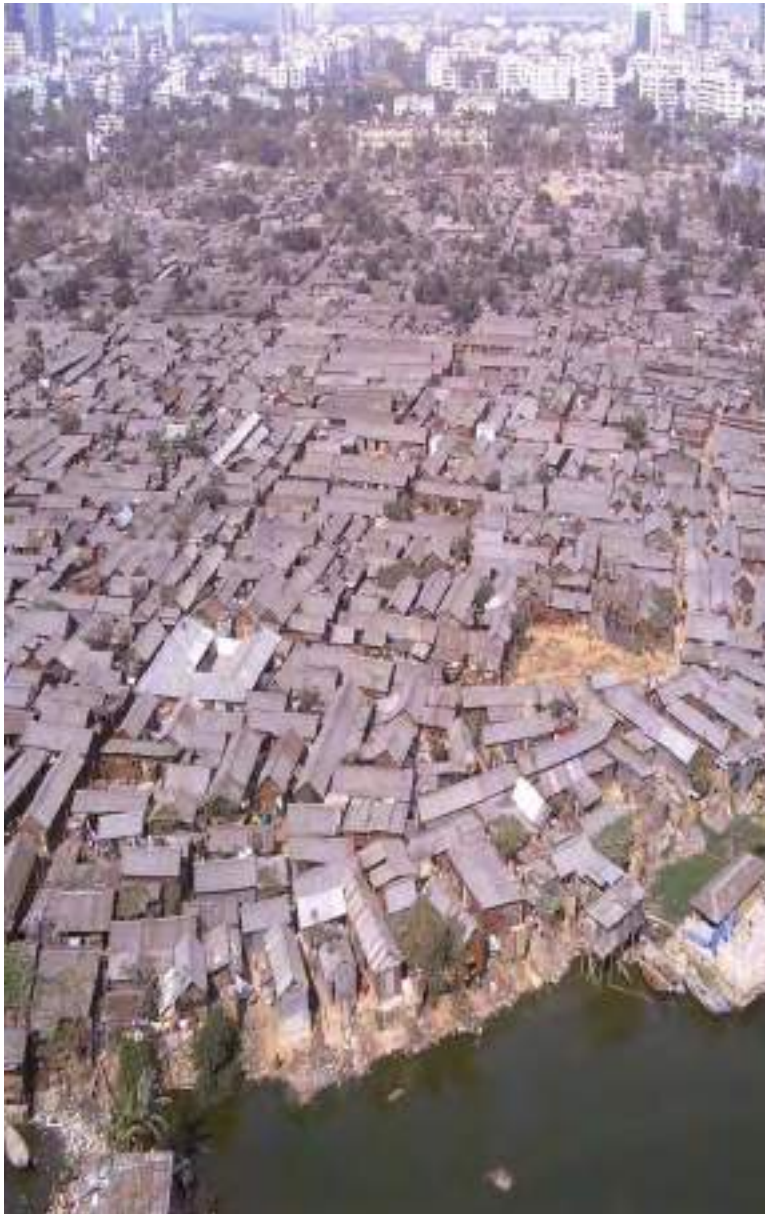

3.0. Photo of Korail Bastea

Type of home-based jobs and % of slum women involved	Bedroom	Kitchen/ Dining	Veranda	Courtyard/ Backyard	Path	Space between buildings	Ben addition	Altered or changed space	Total (%)
Badi/Mia Slum									
1. Garments	●●●	●	●	●	●●●	●●			12.8
2. Workshops	●		●	●	●●●	●●			2.2
3. Household goods	●●				●●●	●			3.0
4. Food delivery	●	●●			●●				4.0
% of slum women involved									21.3
Babupara Slum									
1. Garments	●●●				●●	●			2.2
2. Workshops			●●	●		●			4.4
3. Household goods	●●				●●●	●●			2.2
4. Food delivery	●●				●●●				11.7
5. Grocery shops							●	●	1.8
6. Sorting waste paper					●●●				2.2
% of slum women involved									23.8
Babupara Slum									
1. Garments	●●●	●	●	●			●	●	4.4
2. Workshops			●●	●				●●●	5.1
3. Household goods	●●					●●		●●●	2.6
4. Food delivery							●●●	●●●	5.4
5. Grocery shops							●●●	●●●	12.6
6. Sorting waste paper			●	●					3.0
7. Poultry farm								●●	2.8
% of slum women involved									30.7

Extensive use ●●● Moderate use ●● Minimum use ●

3.1. Use of space for home-based businesses and the involvement of women in these activities were evaluated in three low income settlements



3.2. Photo of women participating in activities for home-based income

CHAPTER 3.0

HOUSING

Housing is the most urgent need for the urban poor of Dhaka.²² The annual housing need for Dhaka in 1996 was 120,000 dwelling units per year, more than half of which were required for the urban poor.²³ Many of the initiatives taken by government and social organizations have resulted in “dead aid”, where the money allocated for the cause did not reach the disadvantaged. Units built through public programs are most often bought by the lower-middle-income households due to the high prices and lack of any systems employed to make these units more affordable. Numerous organizations like CARE and the World Bank have initiated large scale aid to the urban slums of Bangladesh, but none included a housing component, and these initiatives have resulted in limited physical improvements of slums in Dhaka. Figure 3.0 shows typical dense housing conditions of slums in Dhaka. NGOs like Grameen and Proshika, among others, are doing successful work in training and income-generating activities in the slums. However, no real initiatives have been undertaken to improve the urban housing conditions, which could be a major step in reaching the goals of these organizations.

Micro-credit programs have proven to be an effective tool in the fight against poverty. Through Dr. Mohammed Yunus’ Grameen Bank initiative, the urban poor have access to micro loans that can be used for small business initiatives. However, credit alone cannot liberate the urban poor from the slums and squatter settlements of Dhaka. An opportunity for home-based income generation can empower women and use the home as a hub for the family’s economic activities (Fig. 3.1-3.2). Current conditions of slums do not allow flexibility for these activities to

Reasons for not applying trained knowledge	Percentage
Lack of space at home for activities	32 %
Problems with child care and household works	15 %
Lack of knowledge about source of raw materials and place of marketing	31 %

3.3. Reasons behind why women do not apply training knowledge

22 Team members of URBIS project et al. Low Cost Housing Design for the Urban Poor. (Dhaka: Centre for the Urban Studies, 2007), 5

23 Rahman, Dr Mahbubur. AED - Architecture for the Economically Disadvantaged. 78-87 (Dhaka: Department of Architecture, BUET, 2007),78

take place (Fig. 3.3).

The income of women is crucial for the survival of low-income families in Third World cities. In the male dominated culture of Bangladesh, women are not given equal opportunities. The impact of women in the workforce is greatly underestimated in the city of Dhaka. In the socioeconomic context of the city, as women are assigned the sole responsibilities of home management and child care, many women fail to participate in income-generating activities. This can be attributed to the absence of assistance with child care and household work. Women from low-income settlements have the potential to self-create jobs and have shown significant results in creating home based income through training.²⁴ Many NGOs are currently working to train poor women for skill development. Income-generating training programs aim to generate skill and make poor women capable and empowered to be self-employed. However, the problem remains that most of these trained women do not continue to apply their knowledge in home-based income due to impermanent tenure and the lack of space for such activities. Most beneficiaries of these programs live in rented houses with a total space of 150-200 ft² with limited access to exterior space. A 16-20 ft² table that might be used for sewing, embroidery, block printing, and ornament making is therefore difficult to fit into their current space. Yet these are some of the most in demand self-created businesses for women.²⁵ More space in the living conditions will encourage low-income women to transform their domestic spaces for economic activities.

The credit received for utilizing trained knowledge from NGOs is often surrendered to their husbands who apply the credit in other activities.²⁶ In this way, the goal of empowering poor women through training and credit is not achieved. After a period of time the women lose the knowledge they gained through the programs, making all the resources invested in their training useless. Along with the lack of space, the tenure security

24 Shihabuddin Mahmud. *Cities*, Vol.20, No.5, (Elsevier Ltd., 2003), 321

25 Fariya Sharmeen and Gulshan Ara Parvin. *AED - Architecture for the Economically Disadvantaged*. (Dhaka: Dept. of Arch.,2007), 116

26 *ibid*, 117

is another factor that becomes an obstacle for home-based income. A study of two tenure conditions for the urban poor reveals that while women in the illegal Babupara slum use their bedrooms for preparing food to sell outside, women in Ershad Nagar, a government initiated project with more space and courtyards, opened restaurants, groceries or other workshops by dividing their interior spaces within the home.²⁷

“A number of studies have emphasized the key role of women, especially in low-income dwellings, as the provider of economic activities and have claimed that the provision of such work actually becomes the fundamental sustenance without which the household would perish. The home hereby becomes not merely a container of human life but an essential shelter for those life-sustaining activities.”²⁸

For the urban poor, a home is used for production as well as other daily activities at different times of the day. This dynamic space is often subject to transformation or self-initiated extension to meet the needs of this income group, which is sometimes essential to save time and money for the entrepreneur’s survival.²⁹ This idea of domestic industry, where work was centered in their homes, was a common belief for most before the Industrial Revolution. Since then the growth of capitalism and urbanization has changed the role of a home.³⁰ However, the urban poor of Dhaka still remain in a state where the home is an integral part of their livelihoods, where a safe and permanent living condition can improve their economic conditions.

27 Shihabuddin Mahmud, *Cities*, 324

28 *ibid*, 321

29 *ibid*, 322

30 *ibid*, 323



CHAPTER 4.0

THE REALITY OF BASTEES

As the city's population continues to grow, access to adequate housing is denied to the low income citizens, forcing them to find shelter in bastees settlements (Fig 4.0).³¹ As a result, 3.5 million people, representing 37.4% of DMA's population, live in bastees.³² An accurate survey of the informal shelters is not possible in the city; however, a preliminary survey report by the Centre for Urban Studies in 2005 found that 4,300 concentrations of bastees were distributed within the city, without basic human needs or services.³³

In its physical form and organization, Dhaka appears like two different cities: the formal city with legal sanction and official patronage and the informal city built inadequately by the urban poor through dweller's own initiatives.³⁴ The bastees of Dhaka are increasing at a rate unmanageable for the city. The accommodations in these bastees are mostly single units used mainly for sleeping purposes with a high population density.³⁵ The increase in corruption, housing demands, and land values has led to a housing market that does not accommodate the needs of the urban poor of Dhaka. They are forced to pay high rent to live in substandard conditions of the bastees, leading to the degradation of the physical and social environments of the

31 Bastees, defined by the Centre for Urban Studies, are areas with very high density and room crowding with poor services in an unhealthy environment. One of the determinants is the area's drainage, which can lead to water-logging during the monsoon season. The socioeconomic status of the community is defined by low income, where more than half the residents have an income below the poverty level of TK 5,000 per month (approximately \$77 CAD). Tenure security and perception of the community were also factors that defined a slum.

32 Centre for Urban Studies et al. *Slums in Urban Bangladesh*, 18

33 Khairul Enam and Afzal Hossain. *AED - Architecture for the Economically Disadvantaged*. (Dhaka: Dept. of Arch., 2007) 165

34 Dr. Qazi Azizul Mowla and Mohammed Sazzad Hossain. *AED - Architecture for the Economically Disadvantaged*. (Dhaka: Dept. of Arch., 2007), 8

35 *ibid*

Slum Population Size (persons)	Dhaka	Chittagong	Khulna	Rajshahi	Sylhet	Barisal	Total
Up to 100	39.1	24.4	45.6	47.7	58.3	33.8	38.5
101-200	22.1	21.5	25.4	28.2	31.5	33.3	24.0
201-300	9.4	12.3	6.3	9.5	5.9	12.5	9.7
301-400	4.8	6.8	4.4	6.2	1.6	4.0	4.8
401-500	0.2	4.0	4.9	1.1	0.0	5.4	3.2
501-1,000	8.4	11.7	7.3	5.8	1.5	4.8	8.1
1,001-2,500	7.1	13.8	4.8	3.4	0.3	4.3	7.4
2,501-5,000	2.8	3.1	0.6	0.6	0.1	1.4	2.3
5,001-10,000	1.6	1.9	1.8	0.2	—	0.6	1.3
Above 10,000	1.0	0.4	0.2	—	—	—	0.6
Total (%)	100	100	100	100	100	100	100
Total # of slum settlements	4,966	1,814	520	641	756	351	9,048

4.1. Distribution of bastees by population size in six major cities of Bangladesh

Characteristics	Dhaka	Chittagong	Khulna	Rajshahi	Sylhet	Barisal	All Cities
Very poor housing	90.4	85.5	86.8	89.7	86.6	86.1	84.6
Very high pop. density	97.5	89.7	85.0	48.5	87.1	88.9	83.8
Very poor environmental service	89.5	88.6	88.6	88.6	86.1	86.9	88.2
Very low Socio-economic status	88.7	88.9	91.3	87.3	86.7	84.1	86.9
Lack of security of tenure	9.4	12.1	8.6	14.5	0.4	6.5	9.4
Number of slum settlements (lit)	4,966	1,814	520	641	756	351	9,048

4.2. Overall characteristics of bastee settlements

city. In Dhaka, over 85% of the bastee inhabitants have incomes below the poverty line, which means more than 1 in 10 bastee inhabitants are not poor.³⁶ Contradictory to the perception of bastees as a settlement of the poorest sector of society, many individuals are forced to live in these conditions despite their economic status due to the scarcity of low income housing in the city. A case study on semi-permanent dwellings in the bastees of Lalbag and Naya Bazar reveals monthly rents that range from TK 1000-3000 (approximately \$15-\$45 CAD) where 52% of the rent varies from TK 2000-3000 (approximately \$30-\$45 CAD) based on amenities such as size of room and in-house kitchen or toilet facilities.³⁷ These room rents suggest that bastee inhabitants are paying higher rent per square foot than non-bastee inhabitants in Dhaka even though the latter is legal and receives far better services. These unjustified rent collections are made possible due to the scarcity of affordable housing within the city.

The bastees of Dhaka are densely populated in flood-prone areas of the city where 60% of these settlements are flooded almost every year, with disastrous floods every five years.³⁸ Most bastees are without legal access to city services. Water, electricity, and gas are accessed illegally in some locations and made into a business by third parties who make the bastee settlers pay high amounts for these services. Many NGOs are stationed around bastees throughout the city, providing invaluable aid, such as access to water through tube wells and educational facilities for women and children. Figures 4.1-4.19 are tables that compare typical conditions in Dhaka bastees with five other major cities in Bangladesh. Figure 4.21 shows drainage problems in a dense Dhaka bastee.

With the increase of land values, bastee settlements continue to become denser. The existence of many bastees is politically motivated and protected from evictions in order to gain votes for future elections.³⁹ Dhaka has a history of violent

36 Centre for Urban Studies (CUS) et al. *Slums in Urban Bangladesh*. 48

37 Khairul Enam and Md. Afzal Hossain. *AED - Architecture for the Economically Disadvantaged*. (Dhaka: Dept. of Arch., 2007), 165

38 Centre for Urban Studies (CUS) et al. *Slums in Urban Bangladesh*, 41

39 Dr. Qazi Azizul Mowla and Mohammed Sazzad Hossain. *AED - Architecture*

bastee evictions and continues to carry on evictions with a lack of resettlement plans. Between 1990 and 1992, there were 30 eviction cases affecting 200,000 people and causing the destruction of properties worth \$2.5 million.⁴⁰ Often the dwellers receive less than 48 hours to clear the locations. This instability in the lives of the bastee inhabitants hampers their abilities to establish long term life and economic plans.

The primary cause of high land prices is the scarcity of land resulting from the geographical location of the city in a delta region. In a city surrounded by low-lying grounds, the population is densely packed in the remaining high grounds that are less susceptible to flooding. On one hand it is a necessity for the city to expand to relieve the pressures of density in the city centre, on the other hand, expansion results in the urbanization of the catchments that further aggravates the flooding problems.

Prior large scale initiatives to create improved housing for the urban poor have shown that donating large sums of money or resources is not a solution to eliminating slums, rather the urban poor must be given the tools to succeed. It is through ownership and the opportunity to participate in constructing one's own home that the urban poor of Dhaka will form greater connections with the physical environment. Proximity to employment opportunities or creating new ones are important elements in a successful resettlement program.

From 1970 to 1980, several resettlement programs were initiated in Bangladesh in order to provide adequate housing for the bastee settlers affected by natural disasters and government evictions. Most of these people were migrants to the city willing to bear miserable living conditions in order to stay within reach of employment. When resettlement plans relocated these settlers outside the city, far from employment opportunities, most returned either to the urban bastees or to their villages.

The Egyptian architect Hassan Fathy has found through building the town of New Gurna between 1945-47 that the complex issues of providing shelter for the poor go beyond beautiful architecture or the services provided. One must

How is the Settlement known?	Dhaka	Chittagong	Khulna	Rajshahi	Sylhet	Barisal	All Cities
Residential Area	22.9	0.3	5.8	0.0	0.0	3.1	13.1
Mohalla	43.9	1.7	56.7	38.4	0.0	80.0	31.2
Colony/quarter	3.3	89.2	7.3	3.8	98.7	3.1	24.8
Camp	0.6	0.00	0.8	0.2	0.0	0.0	0.4
Bastee	18.8	2.5	42.9	7.0	0.0	13.4	14.3
Others	10.4	26.3	26.5	50.5	0.8	0.3	16.2
Don't know	0.0	-	-	-	-	0.0	0.0
Total	100	100	100	100	100	100	100
	4,366	1,814	520	641	750	351	8,048

4.3. Perception of bastee within the community in six cities

Land Ownership Type	Dhaka	Chittagong	Khulna	Rajshahi	Sylhet	Barisal	All Cities
Government Land	25.7	32.6	27.1	21.4	2.5	30.5	27.1
Private Land	70.3	58.7	54.3	60.3	97.2	63.4	68.7
Others	4.0	3.8	18.6	18.3	0.3	6.1	6.2
Total %	100	100	100	100	100	100	100
N	3,420,521	1,465,028	189,442	156,793	97,676	109,705	5,438,165

4.4. Land ownership pattern in bastees by city

City	<2000 TK	2001-3000 TK	3001-4000 TK	4001-5000 TK	Above 5000 TK	Number of Households
Dhaka	3.8	19.6	34.5	27.8	14.6	673,663
Chittagong	21.0	36.8	27.6	11.6	2.9	266,182
Khulna	34.4	54.3	9.4	1.5	0.3	57,826
Rajshahi	8.5	52.1	33.9	4.7	0.5	27,665
Sylhet	0.8	1.9	22.0	69.3	5.9	18,373
Barisal	44.6	44.8	9.9	0.6	0.1	19,460
Total	10.7	26.6	29.6	23.7	9.1	1,043,329

4.5. Household monthly income pattern for six cities

for the Economically Disadvantaged, 9

40 Dr. Mahbubur Rahman. AED - Architecture for the Economically Disadvantaged. (Dhaka: Dept. of Arch., 2007), 78

Number of households Sharing One Tap	Dhaka	Chittagong	Khulna	Rajshahi	Sylhet	Barisal	All Cities
Not Shared	1.4	24.2	38.1	8.7	1.0	--	4.5
2-5	19.8	24.4	4.8	20.9	6.5	25.1	19.6
6-10	45.8	23.7	4.8	34.9	20.3	14.5	40.9
11-20	21.7	15.7	28.8	28.8	45.9	43.5	22.7
21-30	4.7	3.9	23.8	4.4	20.3	8.7	6.4
Above 30	8.8	8.0	--	2.4	5.9	8.7	6.8
Total %	100	100	100	100	100	100	100
N	4,841	738	21	206	292	89	5,365

4.6. Tap water sharing patterns by city

Number of households Sharing One Tube Well	Dhaka	Chittagong	Khulna	Rajshahi	Sylhet	Barisal	All Cities
Not Shared	27.9	2.4	--	2.8	--	4.5	4.0
2-5	6.5	16.0	7.4	52.0	6.6	2.9	17.3
6-10	27.4	37.4	18.3	24.3	30.0	13.6	26.8
11-20	29.2	30.4	42.5	15.6	40.9	43.4	31.8
21-30	5.0	7.9	16.8	5.0	14.1	19.3	10.1
Above 30	7.0	5.8	15.0	0.3	6.4	16.1	7.6
Total %	100	100	100	100	100	100	100
N	401	1,391	513	624	487	311	3,727

4.7. Tube well sharing patterns by city

City	Municipal Tap	Tube Well	Other Sources	Number of Households
Dhaka	81.7	15.6	2.7	673,883
Chittagong	34.2	57.9	7.9	266,182
Khulna	1.0	98.9	0.1	37,826
Rajshahi	15.7	84.3	--	27,665
Sylhet	35.3	63.0	1.7	18,313
Barisal	8.7	91.3	--	19,460
All Cities	62.7	33.4	3.8	1,043,329

4.8. Sources of drinking water

City	With Electricity		With Cooking Gas	
	Percent of citizens	Percent of households	Percent of citizens	Percent of households
Dhaka	97.1	95.4	81.2	57.8
Chittagong	95.5	87.4	54.7	27.8
Khulna	91.5	72.5	--	--
Rajshahi	85.2	72.7	--	--
Sylhet	95.1	93.4	36.0	16.1
Barisal	98.8	95.8	--	--
All Cities	95.5	91.9	58.5	44.8

4.9. Access to electricity and cooking gas

City	Sewerage/ Septic Tank	Water Sealed	Pit	Hanging	Open	Others	Total Households	
							%	N
Dhaka	33.7	1.9	46.3	13.9	3.2	1.0	100	673,883
Chittagong	10.9	6.4	60.5	16.0	5.7	0.4	100	266,182
Khulna	1.0	9.1	79.9	4.0	5.2	0.0	100	37,826
Rajshahi	5.6	31.5	50.6	8.8	3.5	0.0	100	27,865
Sylhet	1.6	0.5	90.6	3.8	3.1	0.3	100	18,313
Barisal	0.0	0.4	86.5	0.7	11.9	0.4	100	19,460
All Cities %	24.8	4.0	52.8	13.5	4.1	0.8	100	1,043,329

4.10. Household access to different types of latrines

	Dhaka	Chittagong	Khulna	Rajshahi	Sylhet	Barisal	All Cities
Not Shared	1.1	2.5	1.5	13.1	0.5	8.0	2.5
2-5	48.6	49.8	41.9	61.4	21.0	70.9	47.5
6-10	38.8	37.5	42.9	4.0	50.8	17.1	36.5
11-20	7.8	13.8	11.1	0.9	23.9	2.6	9.9
21-30	1.7	3.4	1.7	0.5	2.0	0.6	1.9
Above 30	1.9	1.9	0.8	-	1.7	0.8	1.6
Total %	100	100	100	100	100	100	100
N	4,966	1,814	520	641	756	351	9,048

4.11. Household latrine sharing pattern

Garbage Disposal	Dhaka	Chittagong	Khulna	Rajshahi	Sylhet	Barisal	All Cities
Fixed Place	54.6	33.0	42.1	16.2	43.6	12.0	44.3
No Fixed Place	45.4	67.0	57.9	83.8	56.3	88.0	55.7
Don't know	0.0	-	-	-	-	-	0.0
Total %	100	100	100	100	100	100	100
N	4,966	1,814	520	641	756	351	9,048

4.12. Household access to garbage disposal

Garbage Collection	Dhaka	Chittagong	Khulna	Rajshahi	Sylhet	Barisal	All Cities
Regular	55.7	24.7	19.6	11.9	15.1	7.4	39.0
Irregular	9.2	10.0	20.3	17.2	8.9	6.3	10.4
None	35.1	65.4	59.5	71.0	76.1	86.3	50.5
Don't know	0.1	0.1	-	-	-	-	0.0
Total %	100	100	100	100	100	100	100
N	4,966	1,814	520	641	756	351	9,048

4.13. Household garbage collection pattern

House size in Sq. Ft.	Dhaka	Chittagong	Khulna	Rajshahi	Sylhet	Barisal	All Cities
up to 50	2.1	0.3	2.3	0.0	4.6	0.3	1.8
51-75	17.9	2.4	10.8	0.0	22.5	0.0	12.8
76-100	61.0	25.1	20.0	28.9	46.0	12.5	46.0
101-125	16.0	37.6	41.3	37.3	11.8	43.0	24.0
126-150	1.5	21.2	19.2	32.1	3.2	34.8	10.1
151-200	0.4	11.6	5.6	0.5	8.3	8.5	3.9
Above 200	0.3	1.7	0.8	0.0	3.4	0.3	0.8
Don't Know	0.8	0.6	0.0	1.2	0.1	0.6	0.5
Total %	100.0	100.0	100.0	100.0	100.0	100.0	100.00
N	4,966	1,814	520	641	756	351	9,048

4.14. Size of house or room in bastees for six cities

NGO Coverage	Dhaka	Chittagong	Khulna	Rajshahi	Sylhet	Barisal	All Cities
One NGO	11.3	7.2	27.1	7.0	34.8	13.1	13.1
More than one	58.5	56.4	41.3	86.0	40.7	81.2	58.4
None	30.2	42.4	11.5	7.0	24.5	5.7	28.5
Don't know	0.0	0.0	0.0	0.0	0.0	0.0	0.0
Total	100	100	100	100	100	100	100
N	4,966	1,814	520	641	756	351	9,048

4.15. Percentage of slums covered by NGOs in six cities

Drainage	Dhaka	Chittagong	Khulna	Rajshahi	Sylhet	Barisal	All Cities
Well drained	11.4	2.7	10.2	1.2	6.3	59.6	10.3
Moderately drained	30.0	38.4	51.1	74.6	39.8	34.2	37.0
Poorly drained	58.7	59.0	38.6	24.2	53.8	6.0	52.7
Total %	100	100	100	100	100	100	100
N	4,966	1,814	520	641	756	351	9,048

4.16. Drainage conditions in bastees of six cities

	Dhaka	Chittagong	Khulna	Rajshahi	Sylhet	Barisal	All Cities
Fully flooded	36.5	26.4	6.1	0.3	10.0	2.3	26.6
Partly flooded	22.4	52.1	36.0	2.2	26.2	6.5	27.4
Flood free	39.1	27.4	57.9	97.5	63.8	91.2	46.1
Total %	100	100	100	100	100	100	100
N	4,966	1,814	520	641	756	351	9,048

4.17. Flooding in bastees of six cities

first understand the culture and lifestyle of the economically disadvantaged. When projects become fixated on the problem at the large scale it rarely solves the issues at the human level. The New Gournia project was an initiative that was undertaken by the Government of Egypt in order to relocate a village (Fig 4.20). Even though the homes were provided without cost, a small number of residents continued to live there. The housing needs of the poor were not all met and design choices made by the architect proved unsuccessful in forming a relationship with the residents. Aesthetic qualities of the project were not understood by the locals. The use of courtyards, a rare concept in rural Egyptian architecture, was not successful with the residents. Additionally the use of domes throughout the project was unpleasant to the residents because it made too strong a connection with sacred spaces. When designing for the less fortunate it is important to consider their distinct lifestyle in order for the residents to make a connection with the built environment. While Hassan Fathy was successful in designing a sustainable village using local materials, his attempt to have the villagers follow his prescribed pattern of living was a failure. Figure 2.1 is a photo of a bastei in Dhaka.

City	Owner	Rented	Rent Free	Total	
	%	%	%	%	N
Dhaka	11.7	77.2	11.1	100	673,883
Chittagong	16.5	73.6	9.9	100	266,182
Khulna	17.5	59.4	23.1	100	37,826
Rajshahi	56.9	17.7	23.4	100	27,665
Sylhet	0.5	96.3	3.1	100	18,313
Barsal	24.9	49.2	25.9	100	19,480
All Cities	14.5	73.9	11.7	100	1,043,328

4.18. Rental status of bastei inhabitants in six cities

City	Business/Trade	Hawker/Vendor	Service	Day Labour	Domestic Worker	Transport	Factory Worker	Others	Total
Dhaka	10.1	3.7	10.6	18.6	5.0	24.0	22.4	5.0	100
Chittagong	9.4	1.5	10.2	25.3	2.6	23.0	21.3	6.5	100
Khulna	0.5	1.9	5.0	32.0	3.1	31.3	13.8	3.2	100
Rajshahi	20.3	0.6	6.6	32.8	1.2	30.4	0.3	5.9	100
Sylhet	6.1	2.3	8.9	29.1	3.2	41.3	0.6	8.4	100
Barsal	14.0	2.3	9.2	54.3	1.7	5.6	7.4	5.4	100
Total	10.5	2.8	10.0	24.0	3.9	25.4	17.7	5.6	100

4.19. Occupation of bastei inhabitants in six cities



4.20. Photo of village of New Gournia

4.21. (next page) Photo of a bastei in Dhaka



January, 2009

I began preparing for my thesis with the hopes of designing a housing prototype for the low income families of Bangladesh. I began researching the city, the economically disadvantaged, and their conditions. My research quickly led me to the problem of floods in the city. Despite many other obstacles in the lives of the urban poor, floods appeared to have an overpowering effect on the likelihood of escaping poverty. The climate of Bangladesh dictates the way people live, especially the poor. In North America we are able to control the climate within our living spaces. When nature gives us undesirable conditions, we hide away in our airtight enclosures. In Bangladesh, the majority cannot afford such luxury and must adapt to the climate. The urban poor of Dhaka cannot afford designs that keep out the natural environment; instead they resort to temporary structures that are often washed away in floods.

Through my research on the life and conditions of the urban poor, it became apparent that there was a great need for adequate housing. The problem of housing the urban poor was so great that designers rarely approached it with a serious plan. The government is not willing to spend any more money to house the urban poor. NGOs provide housing for the rural poor, but only provide fragmented services throughout the slums of Dhaka in the hopes of containing the problem. I

saw a need for affordable housing for the urban poor that would be protected from floods. I began with a belief that a safe and permanent home can allow the urban poor to plan for the future and break the cycle of poverty. Temporary relief can be provided with access to toilets, food and other services without cost, but the urban poor need a permanent residence with adequate services that is owned by the residents to ensure they take responsibility for their surroundings.

After brief conversations with my family and friends in Toronto, it was evident that the urban poor of Dhaka remained invisible to the rest of society. They said the idea of a city overtaken by slums was a problem of the past, but this greatly contradicted what I had read. I soon realized I would not be able to read their stories and understand their lifestyles from either source. I knew, even with my past experiences in Dhaka, that I did not know enough about the real conditions of the urban poor to design for them. I needed to walk in the narrow streets of the slums, enter the tiny sleeping rooms of the poor and speak to them about their necessities to truly understand their housing requirements. This led me to entering the IDRC (International Development Research Centre) ECOPOLIS Research Grant and Design Award Competition. The competition is awarded to graduate students with research and design projects that ease the environmental burdens borne by the urban poor in developing countries.



CHAPTER 5.0

AMPHIBIOUS ARCHITECTURE

Buildings are made for land, and boats are made for water. The idea that architecture can transverse these thresholds and allow human beings to experience life in water and land within one dwelling is being adopted by a handful of designers around the world. Amphibious architecture, structures designed to function both on land and water, is a response to the risk of floods in low lying areas (Fig 5.0). At the time this study began, only two sites of engineered amphibious buildings existed according to the research conducted for this thesis. Figure 5.1 shows one of these sites, the Maasbommel harbour in the Netherlands with amphibious houses. The second site with an amphibious house was the Noah's Ark Project in New Orleans. It seems that in the advent of rising sea levels due to climate change and disastrous floods, there is a greater need for flood protection at the scale of residential structures. Residents in flood prone areas around the globe are showing resistance to permanent static elevation, which has been a common strategy to keep homes above water levels. Despite the efforts of raising the structure on a plinth or stilts, protection from floods remains unpredictable due to a limit in elevation. A house raised high above the ground disrupts the connection of the residents to the neighborhood and causes daily inconveniences.⁴¹

In the case of Bangladesh, raising the homes to stay protected from floods is the common solution. The history of the Bangladeshi people is closely tied to the earth. Farming is a major occupation amongst the population. Most of Dhaka's low income families were once farmers who have moved into the city in search of better opportunities. Therefore a strong relationship with the earth is a common thread with this group of people. In walking through the many slums of Dhaka, it is obvious that

41 Buoyant Foundation Project, <http://www.buoyantfoundation.org/> (Accessed October 2010)

What need the bridge much broader than the flood?

William Shakespeare

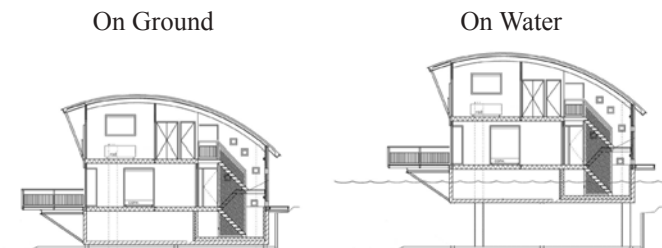

5.0. (opposite) Photo of the Maasbommel harbour

5.1. Diagrams of the Maasbommel amphibious house on ground and on water



5.2. Amphibious house in Maasbommel, Netherlands



5.3. Amphibious house in Maasbommel, Netherlands

the “uthan”, a form of a backyard or front yard of a house, is a valuable space where people perform important activities connected to their livelihoods. A permanent separation from ground is far from ideal for the low income families of Dhaka.

Amphibious architecture is a low-cost, low impact solution that enhances a community’s flood resilience. It provides an opportunity for a flood prone house to remain on the ground under normal circumstances, retaining its relationship to the street. During a flood, the house is lifted by rising waters to ensure it is always dry, and then returns to ground as the floodwaters recede. Amphibious architecture is a cost-effective, safe alternative to permanent static elevation and can be achieved by the implementation of buoyant foundations.⁴²

The very first fully engineered amphibious structure was designed and built by Factor Architecten and DuraVermeer at Maasbommel in Netherlands as a response to rising water levels (Fig. 5.2-5.3). Netherlands, like Bangladesh, is a delta country that is one of the most vulnerable locations for rising sea levels. The Maasbommel project consists of 34 amphibious houses that are able to float up with rising water levels and return to their original locations on the ground when the water recedes. Figures 5.4-5.9 shows the construction sequence for the amphibious houses. Each house is built on a water tight hollow concrete basement that becomes a buoyant foundation for the house when it floats on water. The houses can reach a maximum height of 18 ft by sliding along two vertical mooring poles that are permanently inserted into the ground between each pair of houses. These poles restrict horizontal movements to ensure the houses do not float away when the water levels are high. PVC piping allows flexible connections for plumbing, electrical, and natural gas during both positions of the house whether floating or on the ground. This is different from houseboats or floating homes which are designed to float on water at all times. In addition to the amphibious houses, the Maasbommel project has 15 continuously floating houses on water.

42 Buoyant Foundation Project, <http://www.buoyantfoundation.org/> (Accessed October 2010)



5.4. Reinforcement for the amphibious foundation



5.7. Ground floor completed of the amphibious houses



5.5. Connection of two buoyant foundations to the steel mooring poles



5.8. The two houses sit on a shared platform that allows them to float together



5.6. Concrete foundations, poles and flexible plumbing connections



5.9. Roof installation on amphibious houses



5.10. Vertical guidance system for the LSU prototype



5.11. LSU prototype demonstrating floatation of amphibious structure

In 2005, consequences of Hurricane Katrina and the levee failures devastated the city of New Orleans, USA. The city's flood infrastructure was compromised due to the storm surge, strong winds, and massive rainfall, which inundated 80% of the city. After a loss of 1,800 lives and a population drop of 34% in four years, the city of New Orleans has set new regulations for flood protection involving permanent elevation as a measure to protect houses from future flood damage.⁴³

Dr. Elizabeth English, formerly a research professor at the LSU Hurricane Center and currently an associate professor in the School of Architecture of the University of Waterloo, began the initiative of applying amphibious foundations to pre-existing houses in order to sustain the culture and lifestyle of local New Orleans residents. The Buoyant Foundation Project (BFP) is a non-profit research initiative started by Dr. English in 2006. A year later, a team of Louisiana State University (LSU) Hurricane Centre faculty and students, under Dr. English's supervision, successfully constructed a full-scale prototype of a buoyant foundation system installed on a platform structure representing a partial "shotgun" house with a width of 13 ft and a length of 24 ft. The foundation, designed to be retrofitted to an existing house in Louisiana, is to be constructed with a structural sub frame holding the Expanded Polystyrene (EPS) buoyancy blocks that attach to the underside of the house. Metal columns were inserted into the ground wrapped with metal sleeves attached to the sub frame to allow the house to float up with rising water (Fig. 5.10). Stability tests were performed by distributing sandbags within the structure to represent live loads. The finished prototype of an amphibious shotgun house successfully demonstrated the ability of implementing a buoyant foundation on pre-existing flood affected homes (Fig 5.11).⁴⁴

The precedent of this buoyant foundation was found in rural southern Louisiana where clusters of amphibious housing have been reliably functioning for over thirty years. These

43 Dale Morris, David Waggoner and Han Meyer. *Dutch Dialogues*. (New Orleans: SUN, 2009), 13

44 Dr. Elizabeth English, *Amphibious Foundations and the Buoyant Foundation Project: Innovative Strategies for Flood-resilient Housing*, 2008, 7

houses have proven to be more cost-effective and convenient for the residents. Raccouri Old River in Point Coupee Parish is one of the locations where residents have opted for buoyant foundations to stay dry. The water level in Old River rises and falls with the Mississippi River's spring floods, causing regular damage to surrounding areas. In order to overcome this reoccurring problem, local residents and fishermen devised an amphibious foundation system that allows their homes to float during floods. Buoyancy is achieved by attaching large blocks of Expanded Polystyrene (EPS) underneath the home that has been raised to 3-4 ft above the ground. Long poles sunk into the ground around the house act as the guiding posts for vertical movement. Metal sleeves are placed around these poles and attached to the structural frame of the house to allow the house to slide up and down these guiding posts. The houses in south Louisiana are examples of vernacular adaptations to the climate by implementing simple solutions in order to change a standard static home to an amphibious home.⁴⁵

The Noah's Ark Project was constructed in New Orleans by Spatz Developments in 2007, but it has yet to receive an occupancy permit. The house has gone through a difficult permitting process since amphibious foundations are not yet recognized as standard practice. The house is supported on a hollow steel box which provides buoyancy, which in turn sits on a concrete slab-on-grade. Vertical movement is controlled by four wood posts that are set at the corners of the house with sliding steel sleeves around the posts. The sleeves are welded to the structure of the house.⁴⁶

Indigenous examples of floating structures can be found around the world. These permanently floating structures are an alternative to living statically on ground where the livelihoods of the residents are based on water. In Halong Bay, located in Northeast Vietnam, small communities of local fisherman have created numerous floating villages. The villages consists of houses constructed out of bamboo and wood. The houses are kept buoyant by empty metal drums attached to the underside of the



5.12. Floating village on empty drums in Halong Bay, Vietnam



5.13. Floating houses in Agusan Marsh, Philippines

45 Dr. Elizabeth English, Amphibious Foundations and the Buoyant Foundation Project: Innovative Strategies for Flood-resilient Housing, 2008, 4
46 ibid, 5



5.14. Floating houses on empty drums in Chong Kneas, Cambodia



5.15. Front veranda used for daily activities

wood frame foundation (Fig 5.12). These floating structures have a variety of uses, such as commercial spaces, electric generator storage, and entertainment spaces for the community.⁴⁷

Agusan Marshes in the Philippines is a complex of freshwater marshes and watercourses with numerous small shallow lakes. The development of a floating village was the grass roots response to the excessively fluctuating tide waters and frequent earthquakes. The houses that remain on the shore are at constant risk of destruction, while the floating houses adapt to the environment to mitigate these risks. The houses float on a bamboo and log construction to allow storms to pass through with minimal damages and are easily fixed with little cost. The floating houses are anchored to tree trunks in order to avoid constant movement, but retain the flexibility of anchoring the house in a new location for better fishing opportunities.⁴⁸

The Chong Kneas floating villages in Cambodia are situated in one of the most economically disadvantaged areas of the country. The floating wood frame houses are built upon bamboo mats, metal drums or boat hulls (Fig 5.14). The veranda sits 1 m above the water level (Fig 5.15). These houses are constructed to be movable across the rivers as required by the fishermen.⁴⁹

Methods such as these of adapting to the climate and accommodating fluctuating water levels are becoming a necessity for flood-prone areas of Bangladesh. The indigenous response for a rural homestead began with digging a pond and using that soil to raise the home on a plinth. This was a practical strategy not only to raise the home but at the same time create a holding tank for excess water from the monsoon season in the pond. Though these strategies do not always prove to be enough during critical floods, they were designs in the right direction in trying to **live with water**.

47 Halong Bay Vietnam, (Accessed October 2010) <http://www.halongbay-vietnam.com/photos/people.htm>

48 FloatingCommunities.com (Accessed October 2010) http://www.floatingcommunities.com/cgi-bin/bizdb-search.cgi?template=article_uk&dbname=fc_uk&fl=18&action=searchdbdisplay

49 Peace of Angkor, (Accessed August 2010), <http://www.peaceofangkorweb.com/TonleSap.htm>

CHAPTER 6.0

THE ENVIRONMENT

Bangladesh has a rich palette of tropical flora and fauna. However, rapid urbanization is quickly depleting these rich natural resources with no signs of measures to stop the depletion. The national flag of Bangladesh, a deep red circle surrounded by green, symbolizes the mark left on the luscious green lands of Bangladesh from the bloodshed in the fight for freedom (Fig 6.0). The idea that the country is rich in natural resources is engraved in the minds of its citizens. A picture of a country with deep green landscapes is in the collective memory of the city, where the slow poisoning of the natural environment is not visible. Environmental degradation is taking place at a rapid rate within the urban centres of the country. Dhaka is at the heart of this problem, where the concepts of sustainability and green architecture are not yet evident in mainstream construction. Poverty and environmental deterioration are linked in a downward spiral, with increases in population aggravating both.⁵⁰ Since the construction process of the built world produces a large portion of the negative impacts on the environment, it is vital that future buildings in Bangladesh be designed to be sustainable.

Global warming is one of the most pressing issues for architects of our time. We have come to realize that there are consequences for the irresponsible usage of natural resources. The more advanced our civilization becomes, the further we get from our natural environment, leaving behind irreversible damages. It is only natural that we look back in history in search of simple solutions that have proved adequate to sustain a comfortable living.

Buildings are designed today to keep out the natural environment and protect human life from the exterior. It is

Despite his mania for mechanical comfort, his chances for finding relaxation hinge on its very absence

Bernard Rudofsky - A Human Designer



6.0. Flag of Bangladesh

50 Dr. Qazi Azizul Mowla and Mohammed Sazzad Hossain. *AED - Architecture for the Economically Disadvantaged*, 9

therefore ironic that urban dwellers of Dhaka periodically escape to the villages to find comfort amongst the natural environment. The city is abandoned every year during civic holidays as residents travel to the villages. Almost every urban dweller is in some way connected to the village, whether directly or through a distant family member; therefore it holds cultural importance to ensure one has a village home to which to escape. Urban dwellers find it difficult to completely disassociate themselves from the natural environment, and thus seek connections through the periodic visits to what is seen as the natural state.

The vernacular architecture of Bangladesh uses materials and design that best suit the climate and culture of the region. It is a result of communal design that existed through the activities of a group of untutored builders. Through centuries of experience the designs were adapted to accommodate the most efficient use of materials and methods for the region. Instead of trying to conquer nature, the idea was to cooperate with the environment.

Rapid urbanization has caused architecture to move away from vernacular design towards the use of modern materials that do not suit the climate and culture. Inappropriate materials and methods of construction are chosen due to the perceived notion of advancement. Corrugated tin is one such material that has become a symbol of status amongst the poor, yet poses numerous problems with rusting, thermal comfort, and safety. Rural areas are readily replacing the use of mud and bamboo in local housing with corrugated tin sheets due to its association with urbanization.

In order to understand how to design a sustainable house for the present lifestyle of the urban poor, it is important to study the local traditional architecture which can be found outside the city borders. The rural homestead is the vernacular design of a family home that satisfies the needs of the dwellers. It is an accumulation of interior and exterior spaces to suit the activities of the rural lifestyle. A typical list of homestead members includes people, plants, animals, and birds. These homesteads are built through the rural areas of Bangladesh which dominate nearly 76% of the land area.⁵¹ The design involves an introverted central

51 Dr. Fuad H. Mallick and Khondaker Hasibul Kabir. AED - Architecture for the Economically Disadvantaged, 14

courtyard, termed an “uthan”, around which all activities are arranged. This is an important communal space for the family, where a variety of activities take place throughout the day. Built structures are placed around the courtyard, each for a different activity, such as living units, kitchen, bathrooms, and animal sheds. Spaces between the detached structures serve as secondary exterior spaces which often become circulation spaces that connect the courtyard to another large exterior space or gardens. There are endless types of these homesteads throughout the country, some of which cannot be easily defined into categories. Some are so integrally merged with the natural environment, it is difficult to set boundaries. Homesteads of rural Bangladesh are dynamic spaces; however, economic freedom leads to more permanent materials thus more static spaces.⁵² Studies show that people vulnerable to poverty have spaces that are more in tune with the natural order.⁵³ Environmental problems arise when people are guided by individual or collective perceptions and aspirations that result in unsustainable choices in materials and design.

Vernacular materials include the use of the mud, bamboo, wood and thatch; however, people use a variety of recycled and natural materials throughout their homes. Mud homes with thatched roofs are the most common. The majority of the earth found in the region is ideal for creating walls by lapping layers of mud and reinforcing it with bamboo or thatch. These are locally found inexpensive materials that can be used to build structures with very little technology. A plinth is first laid on the ground to raise the floor of the house to protect residents from minor floods, animals, and insects. Walls are then erected and finished with a thatched roof. The women of the homestead carry out daily maintenance of the mud home by lapping a thin layer of mud mixed with cow dung on the interior and exterior floors, and occasionally on the walls to keep the surfaces from cracking and deteriorating.

Bamboo is an indigenous material that has many applications in Bangladesh. The strength, flexibility, and aesthetic qualities of bamboo make it a desirable material. Figure 6.1

52 ibid, 6

53 ibid



6.1. A resident of a bamboo house on stilts is drying rice on the balcony

shows a traditional bamboo house on stilts in the Hill tracts of Bangladesh. It is used in buildings, clothing, furniture, food, handicrafts, jewellery, musical instruments, paper, temporary structures, signage, and much more. However, in Dhaka it is most commonly used as a scaffolding material and temporary structural support for buildings under construction. A construction site is immediately recognized by the dense network of swaying bamboo. Once the building is complete, all the bamboo is transported to the next construction site or disposed of.

Asian cultures used bamboo in ornamentation and engineered structures over a thousand years ago.⁵⁴ South Americans also illustrate historical uses of bamboo in their buildings. Bamboo has an extremely short growth cycle and a high-yield, making it a renewable resource. Growers can quickly replenish a bamboo grove despite a continuous cutting cycle. A single bamboo member becomes fully matured in 3 years and becomes ready to be applied to its varied uses. In comparison to brick, steel and concrete, which are recognized as long-lasting materials, bamboo's local availability and light weight – due to being mostly hollow along its length – make it a very cost-effective building material. With almost no waste, this environmentally friendly product is an excellent building material for the climate and people of Bangladesh. However, local architects and engineers fail to recognize bamboo in mainstream construction and only apply the product in limited interior applications.

Bamboo is an extremely strong fiber with great compressive and tensile strength and high mass-to-weight ratio. Bamboo can be bent, woven, curved, shaped, moulded, or laminated, making it an extremely flexible material. It grows in groves with a foundation consisting of a network of underground rhizome stems and roots that regenerate themselves. It is a plant that can sustain itself with very little maintenance, like routine cutting. The compost of this environmentally friendly material

54 Gale Beth Goldberg. *Bamboo Style*. (Great Britain: Gibbs Smith Publisher, 2002), 13

fertilizes the next generation by nourishing the soil. The bamboo pavilion at Expo 2000 in Hanover by architect Simon Velez exemplifies the remarkable strength and flexibility of bamboo (Fig. 6.2). The two level circular bamboo structure is 40 metres in diameter, with a peripheral overhang that is seven metres wide.⁵⁵

The biggest obstacle in using bamboo is the common perspective that it is a poor man's material due to its traditional uses in rural areas. Contemporary building design has no room for bamboo. Longevity of the material is another obstacle that discourages designers. Bamboo has natural starch content in its core that is attractive to boring insects. Once infected, the insects quickly bore through the bamboo, destroying its structural integrity and slowly breaking it apart. The reluctance to use bamboo as a structural material has resulted in limited advancements in the commercial use of insecticides and chemical treatments to combat boring insects.

Three species of bamboo are used in the LIFT house: Boruck, Jawa and Mulli. These are used in many forms and sizes through the two dwellings. Whole Boruck bamboo poles are used in the structural component of the dwellings, as this species has the most strength. Boruck bamboo is also used in pegs that are inserted into the poles instead of steel rods in a few connections. Jawa bamboo grows tall and straight making it an ideal selection to slit into strips and use in the two layer floor and exterior wall finishes. Mulli bamboo, the softest in texture, is split into thin layers in order to weave into mats used in walls, windows and doors. Gorjon wood is used to align and fasten these bamboo finishes into the walls.

Despite the environmental and cost benefits, this elegant material has not yet been explored by local architects and engineers. The advantage of using bamboo as a building material surpasses its drawbacks, making it an ideal material to be thoroughly explored in the LIFT house.



6.2. Bamboo pavilion of Expo 2000 in Hanover

55 *ibid.*, 14, 34; Simon Velez. *Grow Your Own House*. (2000); Cali Bamboo, (Accessed November 2010) <http://www.calibamboo.com/whybamboo.html>

PHASE - 1 will begin by constructing the service spines and providing all the service on site

Phase-2 will be completed after the amphibious houses are constructed



RAISED COURTYARD
Soil from excavation is used to raise shared courtyard

VEGETABLE GARDEN
Shared garden

SERVICE SPINE
Contains access to service lines, water cistern, and composting tanks

WASHROOMS
Toilets and showers are located on both levels and remain static on ground during a flood

INDIGENOUS MATERIALS
Exterior cladding, interior finishes and roofing is financed by each household through micro-credit loans

ELEVATED WALKWAY
The top of the service spine becomes an elevated pathway and exterior space for residents

AMPHIBIOUS HOUSES
Buoyant foundations are connected to the service spine that act as the vertical guide in the event of a flood

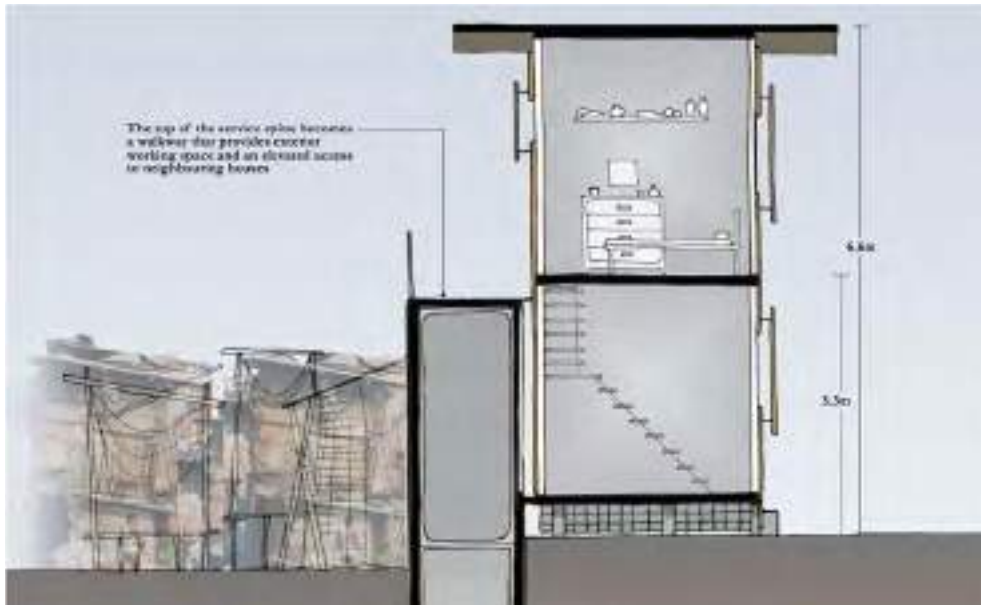

6.3. The LIFT house static on ground during dry season



6.4. The LIFT house floating on water during floods

6.5. (opposite) Rendering of the LIFT community

July, 2009

An introduction to Dr. Elizabeth English's work in designing buoyant foundations in New Orleans sparked my interest and introduced me to the idea of amphibious architecture. When I began designing the house, there was very little information on amphibious foundations. I was working with too many theories and unproven ideas, which was frustrating at that time because I wanted my thesis to be measurable and helpful to Bangladesh. I knew if my thesis remained on paper it would be added to the body of research completed on Bangladesh, but never implemented.

Then the answer came to me in the form of a letter. I received a letter from IDRC notifying me that I had been awarded the ECOPOLIS Research Grant and Design Award on a conditional basis for my proposal of the LIFT house. I was told to downsize the ambitious scale of the project to two houses. Once I made those changes to the proposal, I received the funding that allowed me to visit Bangladesh for field research and construct the two houses in Dhaka which would allow me to test my design. So I packed my bags and began my adventure.

GROUND FLOOR PLAN

SCALE 1:100



LEGEND

- 1. Service Spine
- 2. Amphibious Houses
- 3. Amphibious Houses with Retail Outlets
- 4. Shared Vegetable Garden
- 5. Showers
- 6. Composting Toilets

Amphibious Houses with buoyant foundations are attached with steel connectors to the service spines

Retail outlet opens onto pedestrian streets to allow access for consumers

Flexible design:
Dual access allows compartmentalization of living spaces to allow home based income

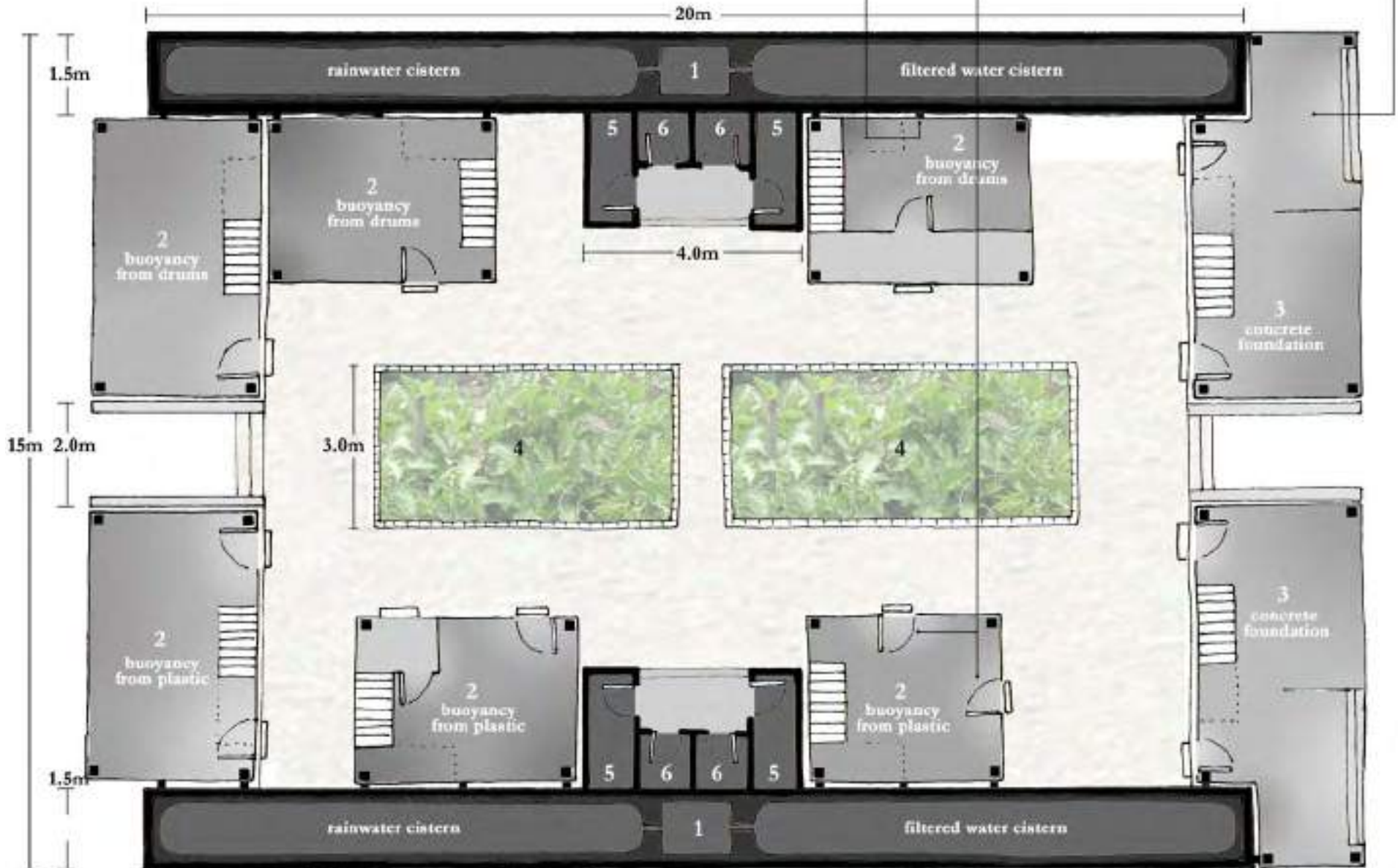

6.6. (opposite) Ground floor plan of a LIFT community
6.7. Interior courtyard of a LIFT community



6.8. Amphibious houses floating in a LIFT community during a flood



6.9. Model of a LIFT house with two dwellings



August, 2009

I stepped out of the Dhaka International airport into a blanket of heavy polluted air. The air coupled with the humid weather made it a challenge to breathe at first. Of course, a month later, I hardly noticed the difference. The residents of the city must not realize the dust and pollution they ingest into their bodies everyday. The lack of open green spaces is a quick indication of the city's planning priorities. As I rode from the airport to my accommodation, it felt like I was visiting Dhaka for the first time even though I was returning after 4 years. In this trip I was far more critical and aware of my surroundings. I was not there just to live in the city, but also to study it. I visited Dhaka in order to perform field research and gain personal experiences. I did this by visiting low income areas, studying materials, and communicating with NGOs, the government, and local professionals in the construction industry.

My first step was to employ an architecture intern who assisted me in conducting the research and providing me with valuable contacts. I chose to hire a female due to my curiosity in

how women are treated in the local construction industry and what it is like for them to practice architecture in Bangladesh. My assistant, Dyutee, was working with a reputable architect at that time which gave me a good platform to begin forming contacts with professionals, many of whom were helpful.

I quickly realized that I needed government support in order to secure land for the pilot project. I knew if I wanted to get support in implementing my project at a larger scale, political attention was required; politics was in the heart of every development in this city. I was lucky that my parents knew the Housing and Public Works State Minister, Advocate Mannan Khan, who was intrigued after hearing my five-minute summary. He invited me to the Ministry to present my idea to his chief engineers and Bangladesh's Chief Architect. This was a huge opportunity and something I did not expect to get so easily.

Early next morning I went to Mr. Khan's office in the Ministry of Public Works. Not knowing what to expect, I was very anxious and nervous about making a presentation in front of such powerful people. I sat across from Mr.

Khan in his large office as we waited for the rest of his advisors to arrive. I knew that a large part of what I could accomplish in Dhaka would be a result of their reactions to my project. I needed land free of cost because my time and funding from IDRC was limited, and this opportunity was my best chance. I waited as Mr. Khan attended to his official duties, signed countless papers, and discussed his week's unbelievably busy schedule. Finally, the group of engineers and architects arrived. Mr. Khan introduced them to me one by one and I immediately realized I was amongst people that made a lot of important decisions for Bangladesh. He gave me a very nice introduction and emphasized that I was being funded by the Canadian government. I was further intimidated by their stern faces. As soon as Mr. Khan gave me an indication to begin my presentation, all my hesitations melted away and I pushed my idea from every angle I could. I suddenly felt confident; I knew the design was interesting and practical for Bangladesh, and I was not asking for money, just a small piece of land that was useless to them. I passed around photos and maps, and occasionally glanced at their faces for reactions. I knew it would be tough to impress the men; they were far too

important to show excitement over a young student's ideas. Perhaps because I was a guest of Mr. Khan, or maybe because I was Canadian, they listened and considered my design seriously.

At first the research engineer tried to prove that the Housing and Building Research Institute had already built similar structures in the past, without truly understanding why my design was different. Once I finished explaining he realized nothing like this has ever been built in Bangladesh, or the world. I often faced this tendency of professionals trying to appear as if they had already done a project like mine. The unanimous reaction of the team was that I should not be building within the city and the project should only be implemented in rural areas. They explained that such a project cannot be sustained in the city and the poor cannot afford it. I explained to them that it is a proposal that could be successful in the peri-urban areas of Dhaka that has lower land prices, where urbanization has crept into what were once rural areas. I further explained that the LIFT house was not designed for the rural population as there would be different issues to consider for their distinct lifestyle. I knew

it was easy to avoid designing for the urban poor, but I pushed them to realize that the issues of housing for the low income population in the city would not disappear if nothing was done, and contrary to the popular belief, high rise apartments are not an appropriate solution for slum settlers. I gave them an example of a project in Mumbai, India. Mumbai is a city with similar cultures and problems to Dhaka, where the slum population has grown to an alarming number. It is a city that Dhaka fears it may become. I explained the projects initiated by the Slum Rehab Scheme in 1995 where private developers were allowed to build high rise towers in existing slums if they handed over a large portion of the apartments to slum dwellers. It proved unsuccessful because only a small number of slum dwellers chose to move into the high rise buildings that were not designed for their lifestyle and needs.

The group seemed very interested in the amphibious idea, more so than creating a sustainable housing solution for the urban poor. I told them I did not need any money but just the land, and that I can show them that it will be affordable for the poor. They explained they were impressed by the

idea and they wanted to give me an opportunity to build it. Though it was not directly expressed to me, I could tell that everyone had doubts that the house would float successfully. They prodded me with questions to test my knowledge, and to boast theirs. I did not mind because I knew the professional culture of Dhaka, and this was to be expected. We debated on locations for the pilot project when Mr. Khan suggested I construct the house within the boundaries of the Housing and Building Research Institute. This seemed like an appropriate location for the house and everyone was on board. Mr. Khan suggested I visit the office of the Chief Architect in order to discuss further details the next morning. At the end of the meeting as I stood to take my leave I was surprised to see behind me was a room full of people who had listened to the whole presentation with intrigued eyes. I was so focused on our talks that I did not notice the 18-20 people who had accumulated behind me while they waited to speak to Mr. Khan. I was glad I did not notice because it probably would have made me more nervous. I felt like the room was smiling at me as I left; it could have been just politeness, but to me it was reassuring.

As I walked out of Mr. Khan's office I felt a sense of relief, but I knew this was just the beginning. I had to impress a lot more people before the project would become reality.

The next morning I visited the office of the Chief Architect; the man who was the voice of architecture for the government of Bangladesh. He discussed my project with limited interest. I could see in the way he talked with me that he did not believe I could construct two amphibious houses, and make them float. As we began talking about the need for amphibious structures in Dhaka, he said what became the most memorable sentence in all my research, "there are no slums in Dhaka, and we no longer have flooding problems".

I was prepared with the statistics, and quoted him some numbers from a study done by the United Nations, which caught him off guard. He quickly shuffled through his phonebook and handed me a name and a number. "Here" he said, "she can help you". I took the number, thanked him, and left his office. I called the number and headed straight to the office, I did not want to lose any time.

The number belonged to Salma Shafi, a respected woman in the field of research on the urban poor of Dhaka. She was a breath of fresh air after my last few meetings. She gave me a new sense of hope and reassured me that my research findings were correct and there was, in fact, a great need for my solution. Since my arrival in Bangladesh, she was the first person who understood the key point and the intent of providing housing for the low income families of the city, instead of focusing on the novelty of the amphibious portion of the project. While in her office, I received a phone call from Mr. Khan who informed me to meet him at HBRI within half an hour.

My visit to HBRI was a surreal experience. After a short presentation by the HBRI staff, we walked through the site and located the ideal plot for my LIFT house. Though Mr. Khan was on an official visit to the centre, it seemed that my project was an important part of this visit. This was both exciting and terrifying at the same time, because what was once a set of lines on paper was now beginning to take form in very real terms.

CHAPTER 7.0 THE LIFT HOUSE

If at first the idea is not absurd, then there is no hope for it

Albert Einstein



7.0. Satellite image of HBRI indicating LIFT house site location

The LIFT (Low Income Flood-proof Technology) House is a response to the need for sustainable, affordable housing in flood-prone areas of Dhaka for the urban poor. The city of Dhaka is incapable of providing basic services, such as access to water, electricity, and a sewage system. The LIFT house is self-sustaining in providing these services without relying on the city infrastructure. The house is designed to be constructed in any low-lying location within the urban and peri-urban areas of the DMA.

The LIFT community is designed with a central courtyard that is shared by eight residential units with communal amenities such as access to water and toilets. The design consists of two parts, the service spines that are static on ground, and the two amphibious dwellings that are flexible to float up and down during floods. Each residential unit is designed to house approximately five family members. After developing the proposal for the LIFT community in detail, the LIFT house pilot project was designed as a smaller version of the LIFT community with two residential units sharing one service spine.

Both proposals are designed to make the house self-sufficient by using passive resources such as solar power, natural ventilation, rainwater harvesting, and composting toilets. The house is designed to relieve the city of the pressures of providing water, electricity and sewage system to these units, and the residents from monthly utility bills. It is more important to have access to clean water, hygienic toilets, and electricity for basic tasks, than the comforts of modern living. Therefore, non-mechanized, simple solutions are utilized to provide the urban poor with these essential services. With minimal maintenance work every few months, residents can enjoy these services without any further cost to bear beyond initial installation.

The LIFT community and the LIFT house are similar in design; the difference is in the scale. The LIFT house was designed for two families as a pilot project to be constructed and tested in Dhaka, in order to limit the size of the project and stay within budget. On November 2009, the LIFT house pilot project broke ground in Dhaka in the HBRI (Housing and Building Research Institute). After a continuous construction period of two and a half months, the inauguration of the LIFT house occurred on January 24th 2010 attended by the Housing and Public Works State Minister, the Finance Minister, and the Agriculture Minister of Bangladesh.

The house is situated beside a pond and close to the road that runs through the grounds of the HBRI in order to easily demonstrate the benefits of the project to visitors (Fig. 7.0). In order to make the dwellings float on demand, the two bamboo dwellings are placed inside two large holding tanks 3 ft in depth that will naturally flood when water accumulates after heavy rain or when pond water is pumped in for demonstration purposes.

SERVICE SPINE

The service spine is constructed out of brick and reinforced concrete. Kitchens, bathroom, composting toilet storage tanks and two types of water cisterns are located in this structure. The interior surfaces of the cisterns are lined with a layer of Ferro cement in order to stop moisture penetration. The foundation for the service spine is a concrete slab on grade with a 15" thick perimeter brick wall with a height of 12". The walls of the service spine are 10" thick with two lintel bands of concrete, one halfway up, and the other at the top to strengthen the brick wall. Two sets of three lintels span across the interior of the service spine to reduce the risk of buckling of the brick walls. A line of dowels is also inserted at both the top and bottom connections of the brick walls to the concrete slabs for a stronger connection by preventing rotation. The top slab of the service spine is a usable exterior



7.1. Perimeter brick wall under construction



7.2. Service spine under construction with two horizontal lintel bands

space accessed through the second floors of the dwellings, making it a safe space for exterior activities during a flood. This exterior space has a concrete floor and with a bamboo railing that is attached with steel rods, concrete, and steel clamps.

WATER

Since access to water provided by the city is becoming scarce even for the planned, upper class communities within Dhaka, the LIFT house pilot project depends solely on harvesting and recycling rainwater through non mechanized systems. A common method of acquiring clean water for the urban poor is through deep tube well pumps. The groundwater pumped through this method is highly contaminated with arsenic chemicals and is one of the reasons the groundwater levels of Dhaka are alarmingly low, depleting at a rate of 10ft every year.

A catchment area of 570 sq.ft. and the city's annual rainfall of 100 inches allows the house to collect a maximum of 100,000L of rainwater. The two water cisterns combined have a capacity of 48,000L which will be adequate for 10 residents throughout the dry season. Rainwater is collected from the roof and the top slab of the service spine in the first cistern and passes through a filter that traps dirt and insects. If small particles of dirt enter the cistern, the natural sedimentation process will settle these particles at the bottom of the cistern. Water is taken from 1ft above this level. Residents have access to this collected rainwater via a hand pump located on top of the service spine. This is the primary source of water for activities such as cooking, bathing, and washing clothes. Drinking water is further boiled. Used water from these activities is collected through a biosand filtration pipe that removes pathogens, chemicals, and all other unwanted substances. This filtered graywater is then accessed through another hand pump for use as the secondary source of water, mainly for toilets, washing, and irrigation. This method maximizes the collected rainwater to fulfill all water

needs of the residents.

Biosand filtration is an effective, low-cost method for household water treatment to allow reuse. It is the earliest form of engineered potable water treatment and remains one of the most efficient methods in improving the physical, biological, and chemical quality of water. Use of locally found materials ensures that a biosand filter can be easily implemented anywhere in the world. The main components to the filter are an enclosure, layers of sand and gravel, a diffuser plate, and pipes to pass water. In the LIFT house the biosand filter is designed with a plastic water pipe as the enclosure that holds 3 layers of sand and gravel, starting with fine sand on top, coarse sand in the middle, and gravel in the bottom layer of the pipe. Water enters the system from the top and passes through a diffuser plate that dissipates the initial force of water. Travelling slowly through the fine sand bed, the water passes through the layers of sand and gravel and collects at the base of the filter. It then moves into the second cistern in order to be reused. When water passes through the fine sand bed, organic materials in the water are trapped in the top layer of the sand bed forming a biological layer termed “Schmutzdecke”. A 2” layer of water is always maintained above the sand layer in order to sustain the Schmutzdecke by providing enough oxygen. Within one to three weeks, this biological layer eliminates pathogens and other contaminants from the water through four processes: predation, natural death, adsorption, and mechanical trapping. Predation occurs when the Schmutzdecke layer consumes bacteria and other organisms from the water. Natural death occurs when pathogens cannot survive due to scarcity of food. Absorption occurs when viruses become attached to the grains of sand, which renders them inactive. Mechanical trapping occurs when viruses, cysts or worms become trapped within the sand grains, removing these contaminants from the water.

Operation and maintenance of the biosand filtration system is easy for the residents to perform. Used water from the bathing and washing area is automatically collected and deposited in the biosand filter and then held in the recycled water cistern for further use. There are no moving parts in the filtration system. The

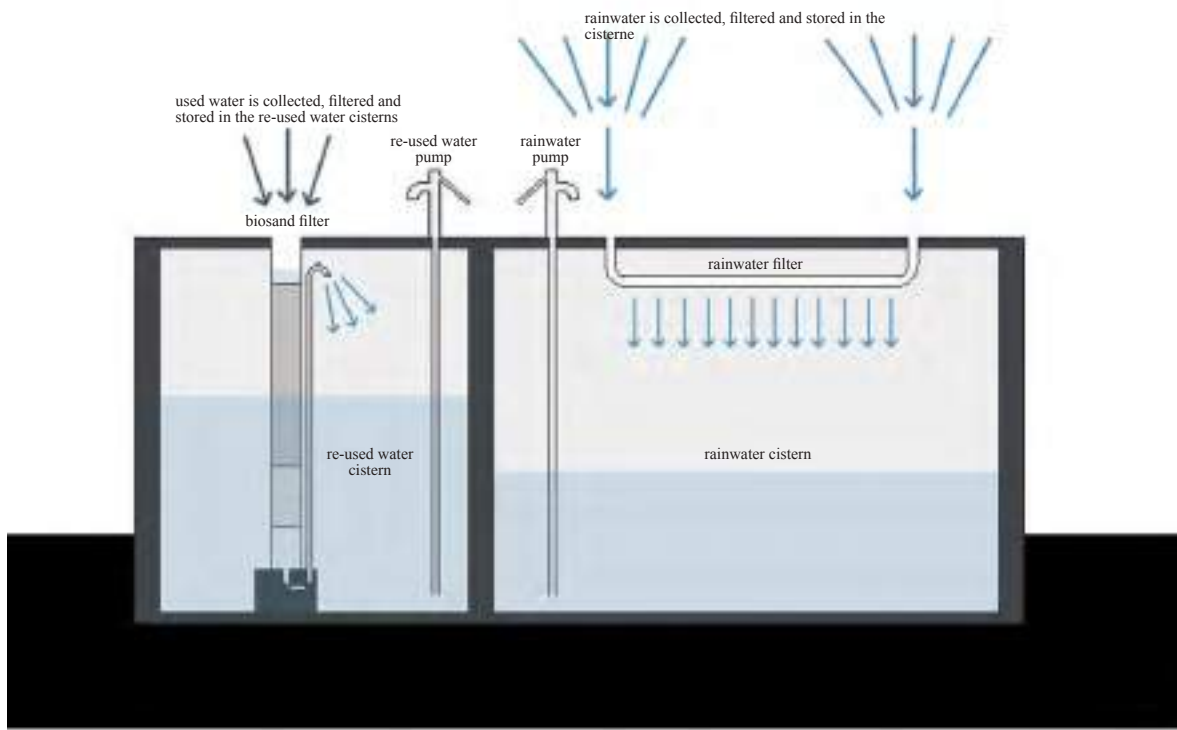

7.3. Diagram of the rainwater harvesting and storage systems

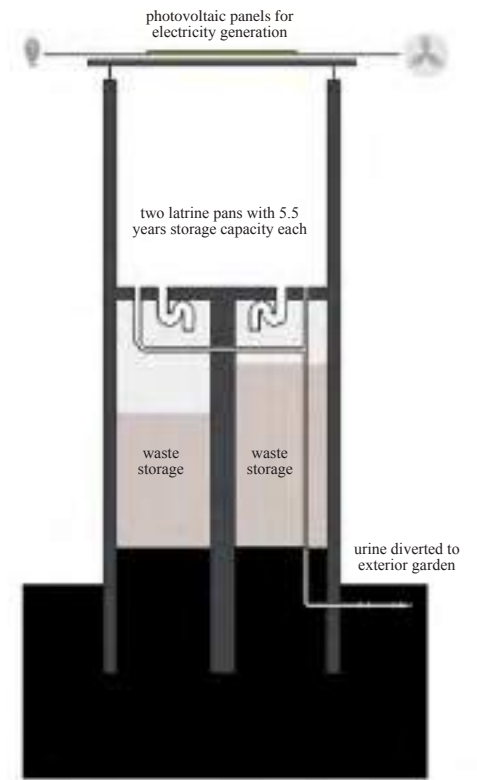

7.4. Diagram of the composting latrine system

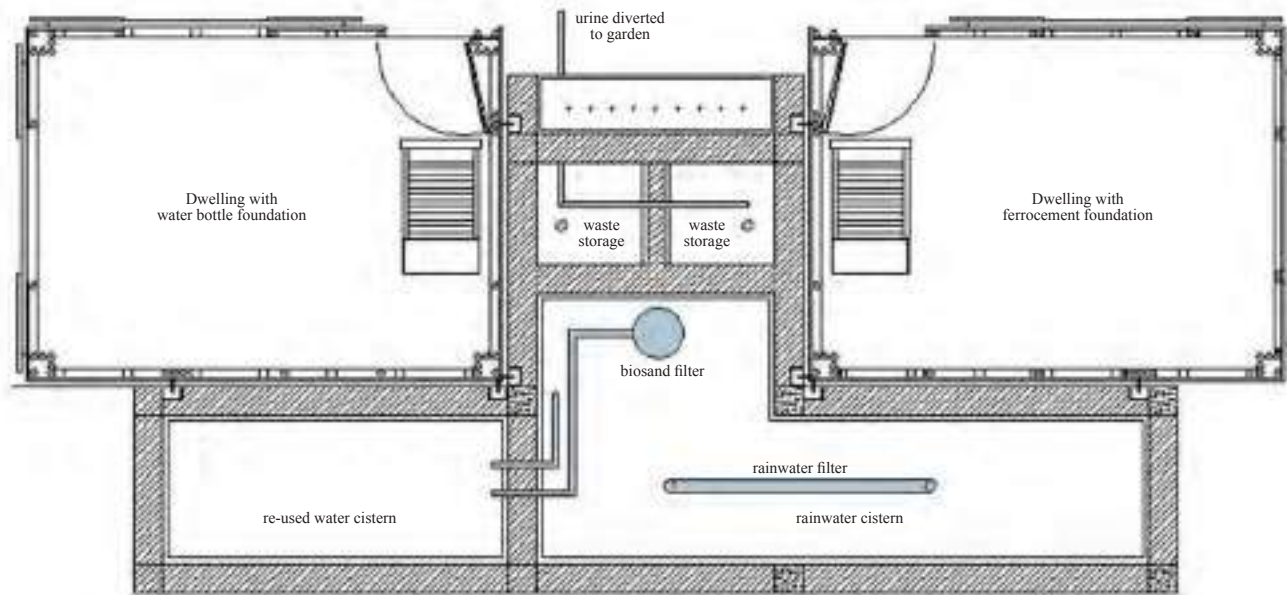

7.5. Plan showing locations of water harvesting and composting latrine systems

Problem with raw water	Effectiveness of treatment method											
	0 = minimal if any effect. - = unknown effect.					1 - 4 = increasing effectiveness. + = helpful to another process mentioned.						
	Straining through fine cloth	Aeration	Storage / pre-settlement	Coagulation, flocculation and settlement or filtration	Fine sand filtration (slow)	Coarse sand filtration (rapid)	Charcoal filter	Ceramic filter	Solar disinfection	Chemical disinfection	Boiling	Desalination / Evaporation
PATHOGENS Bacteria, (effectiveness often also apply for amoebas, viruses and ova)	0	+	1-2	0-1	4	2	-	3-4	4	4	4	4
Guinea-worm larvae (in cyclops)	4	0	0	-	4	2-3	-	4	2-4 b	-	4	4
Schistosomiasis cercaria	-	0	4	-	4	2-3	-	4	2-4 b	4	4	4
NATURAL CHEMICALS ^a												
Iron and manganese	0	+	1	1	3	3	-	-	-	-	-	4
Fluoride	0	-	0	4			-	-	-	-	-	4
Arsenic	0	+	-	4	4	4	-	-	+	-	-	4
Salts	0	0	0	-	0	0	0	0	0	0	0	4
OTHER PROBLEMS												
Odour and taste	0	2	1	1	2	2	3-4	2	0	1	-	3-4
Organic substances	1	1	2	1	3	3	-	3	-	4	-	4
Turbidity (cloudiness produced by suspended solids)	1	0	2	3	4	3	-	4	0	0	0	4

7.6. Effectiveness of household water treatment systems

joint between the filter and the outlet pipe through which the water flows out of the filter and into the cisterns is encased in concrete to avoid future leakage. The top of the filter requires cleaning when there is a decrease in the flow of water. The surface of the fine sand layer can be agitated to suspend the clogging materials in the standing layer of water, which can then be removed using a small container. This process can be repeated until the flow of water returns to normal, at which point the Schmutzdecke layer will form once again. Figure 7.3 compares the effectiveness of different household water treatment systems.

SANITATION

Sewage is commonly thought of as an unwanted part of life. However, for a country like Bangladesh, where access to the urban sewerage systems is very limited, it is beneficial to think of human waste as a resource. The sanitation system of Dhaka is a wasteful user of precious potable water and electricity. The LIFT house redirects the responsibility of sewage disposal from a large centralized system to an on-site composting system, turning urine and solid waste into resources the residents can use. The composting latrine system is designed to fit the principles of the Sulabh Toilet. This low-cost, hygienic dual pit latrine system was designed and applied in India by Sulabh, an organization dedicated to providing the poor with access to affordable toilets.⁵⁶ Unlike the Sulabh toilets, the LIFT house composting latrines divert urine and deposit into the soil of the garden through an underground pipe where it can be used as fertilizer. In many parts of the world, urine has traditionally been separated from solid waste. In Sweden, urine was collected separately from solid waste and poured down drains to prevent latrines from filling quickly. The German scientist, Muller, separated the urine through a specially designed toilet in order to produce fertilizers. The Japanese practice of nightsoil recovery also separated urine and used it as a fertilizer. In Yemen

56

Sulabh Toilets, http://www.sulabhinternational.org/st/sulabh_flush_compost_toilet.php (Accessed July 2009)

the urine has been evaporated and the solid waste used as fuel for over a hundred years.⁵⁷

Urine contains the majority of the nutrients found in wastewater, at the same time it constitutes less than 1% of the total wastewater volume, making it a concentrated fertilizer. Urine collected from one person, (1L-1.5L per day), is sufficient in fertilizing 3 sq.ft. of vegetation.⁵⁸ By diverting the urine from solid waste, the latrine system in the LIFT house is less prone to leaching and will naturally compost at a higher rate. Designing in a flood prone area meant changing the Sulabh model to fit Dhaka's needs. The Sulabh toilet is horizontally designed so that both the latrine and the two storage pits are located close to ground. The latrines for the LIFT house were placed on the second level, accessible from the top surface of the service spine, ensuring that the drain was above the anticipated water level of a flood. The latrine pans were custom designed to divert urine and solid waste with a slope of 25 degrees with water traps to eliminate undesirable smell and flies. Two exhaust pipes take gas buildup from the storage pits to the exterior. One pan and one storage pit can be used for 5.5 years; at which point the storage will be full. The residents will then lift the concrete lid off the second pan and place it on the first in order to use the second storage pit for another 5.5 years. Therefore, the first storage pit can be emptied in 11 years at which point the solid waste would become odourless manure that can be used as soil-conditioner. A small opening with a sealed cap is provided at the level of the pans for both storage pits should any blockage occur and for checking the level of the sludge. The bottoms of the storage pits are open to the soil with openings in the side walls to allow liquids to seep into the surrounding soil in order to dehydrate the solid waste. This system does not contaminate the pond or groundwater since bacteria cannot travel more than 12 ft horizontally and 3ft vertically.⁵⁹ The two families of the LIFT house have access to hygienic sanitation that is eco-friendly, technically appropriate and has no additional utility costs.

Currently approximately 2.4 billion people are lacking safe sewage disposal

WHO, 2002

57 Caroline Schonning. *Urine Diversion - Hygienic risks and microbial guidelines for reuse*. (PhD. thesis, Royal Institute of Technology, 2001), 2

58 *ibid*, 10

59 Sulabh Toilets, http://www.sulabhinternational.org/st/sulabh_flush_compost_toilet.php (Accessed July 2009)

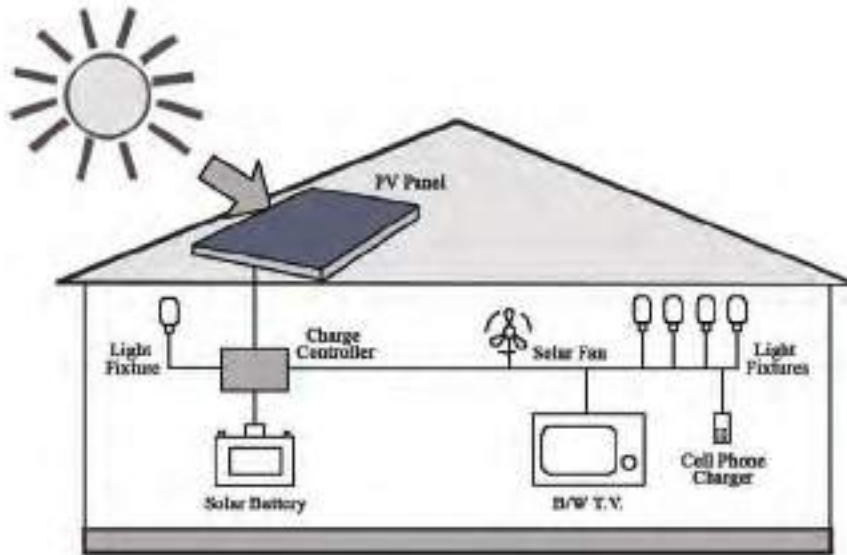

7.7. Diagram of the solar energy system in each dwelling of the LIFT house



7.8. Photovoltaic panel installed on a thatched roof in rural Bangladesh

ELECTRICITY

Electricity is derived from two 60W solar panels, one for each dwelling of the LIFT house. Two Canadian manufactured solar panels were donated by Centennial Solar Inc. Each panel is connected with a local solar battery, wiring and fixtures to provide electricity for 1 fan and 5 energy saving light fixtures for each unit, one on each floor of the dwelling, one at the front door, one in the kitchen, and one in the toilet area, for a period of 6 hours a day (Fig. 7.5). A mobile charger and TV connections are also possible within this system. The fixtures allow ample light for the residents to perform basic tasks. A network of electrical wiring is threaded through the bamboo wall and roof panels. A large slack in the wire that connects the solar panel, located on top of the toilet roof, to the solar battery inside the dwelling allows for the unit's vertical movements during floods.

Only 30% of the total population of Bangladesh has access to the national electricity grid. The country is almost entirely dependant on fossil fuel to generate electricity, which is quickly depleting. The current shortage of electricity is one of the most immediate crises in Dhaka. Load shedding is a process that shuts off electricity in different locations within the urban fabric in order to relieve the pressure on the source. This is commonly felt in every sector and community of Dhaka, profoundly affecting the efficiency and commerce of the city and its services. Solar energy is beginning to play a significant role in Bangladesh, as scientists and NGOs are relying on this passive energy source, and applying it to remote rural areas that have no access to the electrical grid (Fig. 7.6). A few applications of solar panels as an alternative source of energy have been made in the retail and garment industries in Dhaka. However, no real initiatives have been taken in the urban housing industries, since high and middle income groups are dependant on oil-fed generators, and batteries as back-up power sources during load sheddings. Both these options are expensive and harmful to the environment. Solar power, though very desirable, has a

high initial cost for the quantities of power consumed by these income groups. The lifestyle of the urban poor, however, requires minimal electricity to carry on their daily activities, making solar energy an ideal source of power for a city blessed with an abundance of sunlight.

KITCHENS

The cooking area is traditionally a separated space used by the women in the household. In rural homesteads, the kitchen is a standalone structure where women prepare and cook the daily meals and is ideally situated near a water source where the washing is done. The LIFT house kitchen, in following this principle, is located on top of the service spine to ensure a physical separation from the dwelling due to fire hazards and the risk of indoor air pollution. This area is easily accessible to the water source where a designated washing area ensures that the used kitchen water is disposed of and not reused.

Domestic cooking by the majority of the rural and urban poor is done by burning firewood, vegetation, animal excreta, and agriculture residue as fuel, with a heat production efficiency of only 5-15% (Fig. 7.9). There is great potential for the use of biogas in Bangladesh, which is a low tech and environmentally friendly alternative to the traditional methods. Biogas can be used in Dhaka by constructing an underground dome in which organic materials such as cow dung or human waste is stored (Fig 7.7 and 7.8). This goes through a natural fermentation process producing gas that can be used for domestic cooking. Biogas domes are easy to construct with local labour and materials. This technology is best used when applied at the scale of the community due to its initial set up cost and continuous need of organic materials. The LIFT house was too small in scale to make the application of biogas a cost effective method because 10 people will not produce enough human waste to produce enough gas in order to cook three meals a day for two

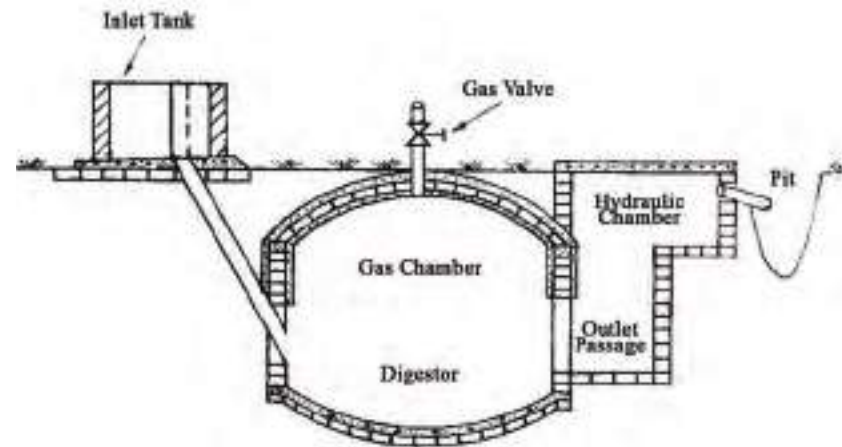

7.9. Diagram of a bio gas fixed dome



7.10. Photo of the top of a bio gas plant



7.11. Traditional wood burning stove with low heat efficiency



7.12. Improved stove with an exhaust chimney

families. Purchasing cow dung from local farmers proved too expensive to become a viable solution, therefore the LIFT house is installed with two Grameen Shakti improved stoves.

Grameen is a diverse organization based on the principles of Dr. Mohammed Yunus, the Nobel Peace Prize Laureate, for his applications of the micro-credit system. Through the Grameen Bank initiative, the most desperate poor have access to micro loans that can be used towards small businesses. Grameen Shakti was established as a social business that provided access to affordable renewable energy to the poor. The improved stove is a product of this organization, extensively applied in rural communities in order to eliminate indoor air pollution and reduce the use of firewood by 50%.⁶⁰ The improved stove is constructed out of brick and locally found mud, with a sieve for inserting organic materials, and a chimney for exhaust (Fig. 7.10).

MATERIALS

Bamboo was the chosen building material for the amphibious dwellings due to its versatility, light weight, environmental benefits and low cost. Bamboo is brought into Dhaka from the groves in the north and south of the city by road and by floating it downstream. Though abundantly available, it is currently used in the construction industry only for scaffolding and temporary structures. The chosen bamboo for the LIFT house was approximately 3 inches in diameter and cut to varied lengths depending on the usage. After receiving the shipments on site the bamboo was cleaned and shaved slightly around the joints, and two holes were drilled at every hollow section of the bamboo. The poles were then submerged in a diluted chemical mixture, a combination of water, boric acid and borax, which protects the bamboo from insect attacks. The holes in the

60 Grameen Shakti, http://www.gshakti.org/index.php?option=com_content&view=article&id=59&Itemid=63 (Accessed July 2009)

bamboo allow the mixture to pass through the interior cavities, breaking down the starch content that attracts insects. After soaking for 7-10 days the bamboo was stored upright in sunlight to drain and dry for 2-3 days, at which point it was ready to be prefabricated for construction.

The construction techniques of Anna Herrerger in the METI school in Dinajpur, Bangladesh, one of the few examples of engineered structural bamboo applications, was a guide for developing the construction methods and connections of bamboo.⁶¹ Since local engineers knew very little about the structural integrity of bamboo, a hands on approach was required for the construction process. The bamboo fibers run vertically along a bamboo pole making this axis far stronger, thereby needing stiffeners to be used laterally. The majority of the bamboo in the structure was used in multiples, so that two or three bamboo poles were combined, prior to assembly, to make one member with greater strength (Fig 7.11). A specialized series of wood clamps were designed and fabricated in order to efficiently attach these bamboo poles together. Two types of connections were used, a metal rod inserted tightly through a pre-drilled hole across two members, and a hand tied nylon rope that counteracted the tendencies of the members to pull apart.

The prefabricated columns of four long bamboo poles with small stiffeners were the first members created. Then a series of beams and secondary columns were attached in sets of two or three. Once all the prefabricated members were ready, the house was quickly assembled.

For a country prone to severe weather, roofing is one of the most important design elements for Bangladesh. Many times, roofing is the most expensive material for the poor in order to stay dry through the monsoon season. The LIFT house roofing was designed to be lightweight, affordable, and maintainable. The common material choice of corrugated tin was rejected due to its inappropriateness to the climate, as well as thatched roofing due to the scarcity of the material in urban areas and its



7.13. Prefabricated bamboo columns for the LIFT house

61 METI School, (Accessed July 2009), http://www.meti-school.de/daten/projektbeschreibung_e.htm



7.14. Peeled bamboo skins



7.15. Sample top layer of bamboo roof

need for continuous replacement. Bamboo was used in three layers in the LIFT house. The topmost layer of all three roofs exposed to the natural elements is designed after an indigenous method of laying bamboo skins which are the top peeled layer of the bamboo, in a pattern that resembles wood shingles. Since this is the most vulnerable layer of the roof, only the Mulli bamboo skins were used, which is the most durable part of the plant. Galvanized metal wire was used to tie the bamboo to the support frame by hand. The second and third layers are the Mulli bamboo woven panels that sit against the frame of the top layer to provide added support. An air and moisture barrier membrane is placed between these layers to prevent leakage. The LIFT house roof system is custom designed based on indigenous methods to suit the amphibious dwellings.

Doors of the LIFT house were made on site to overcome the challenge of designing for varying sizes of the openings in the bamboo walls. Door frames were made from Gorjon wood and clad with bamboo mats on either side. The door handles were cut from a rare species of bamboo that is extremely sturdy and straight. This bamboo was also used in the stair railings that spanned from the ground floor level to become the railings on the second floor.

AMPHIBIOUS FOUNDATIONS

Two types of amphibious foundations were used in the LIFT house. An amphibious foundation allows a house to become buoyant, meaning it has the ability to float when surrounded by water.

The LIFT house required a low maintenance, low cost solution using local materials and labour that would be suitable for the urban poor of Dhaka. Two solutions were designed to test the efficiency and reliability of the foundations, a hollow ferrocement structure and a bamboo frame filled with empty used water bottles. A third option was considered during the

construction process that involved an untested theory of using cement reinforced with wire mesh. This was a light weight alternative to ferrocement but not yet applied to construction in Bangladesh. A small 3ft by 4ft model of this method was made and tested for live load capacity. Though it was efficient in carrying load, the structure showed flaws that eventually caused leakage. The method was rejected since the structure relied too heavily on the quality of the workmanship and was too sensitive to cracks from uneven drying. A second model was constructed to test the foundation with water bottles. A model similar in size, the water bottle foundation performed to satisfactory levels, making it a viable option for one of the dwellings. The drawback noticed in the model was the structure's tendency to tip over when in water. This was taken into consideration when designing the vertical guidance system in order to restrict this movement.

The Archimedes principle states that the buoyant force on a submerged object is equal to the weight of the fluid that is displaced by the object. Since the weight of water is 62.4 lb/ft³, the depth of the foundations were calculated by finding the dead load and live load of the entire structure. The weight of the structure per square foot divided by the weight of water equals the depth the house will be submerged when floating. The average weight of bamboo was taken on site to calculate a dead load of 55 lb/ft² for each dwelling, and a live load of 50 lb/ft². Figures 7.12 and 7.13 shows the calculations for the depth of the amphibious foundations. The ferrocement foundation was designed with a height of 36" and the water bottle foundation at a height of 39" as a measure of safety, since it is impossible to accurately calculate live loads on the dwellings during a flood.

Ferrocement was introduced in Bangladesh in the 1970s, but little advancements and implementations have occurred since then. It is mainly used to make small water tanks by the ferrocement team from HBRI in Dhaka. Ferrocement is the method of applying a mixture of cement, sand and water in layers on wire mesh and steel reinforcement. It is lightweight in comparison to concrete and waterproof due to its cement content and application method. A polymer was mixed into the

Ferrocement Foundation:	
D. L. of dwelling: 55 lbs/sq.ft. D. L. of foundation: 52 lbs/sq.ft.	L.L. on 1st floor: 20 lbs/sq.ft. L.L. on 2nd floor: 20 lbs/sq.ft. L.L. on roof: 10 lbs/sq.ft.
Total Dead Loads: 107 lbs/sq.ft	Total Live Loads: 50 lbs/sq.ft
<p>Total Load / Weight of Water = Minimum Depth of Foundation</p> <p>$157 / 62.4 = 2.5\text{ft}$</p> <p>As a safety consideration , a foundation depth of 36" was applied</p>	

7.16. Calculations for the depth of the ferrocement foundation

Water Bottle Foundation:	
D. L. of dwelling: 55 lbs/sq.ft. D. L. of foundation: 20 lbs/sq.ft.	L.L. on 1st floor: 20 lbs/sq.ft. L.L. on 2nd floor: 20 lbs/sq.ft. L.L. on roof: 10 lbs/sq.ft.
Total Dead Loads: 75 lbs/sq.ft	Total Live Loads: 50 lbs/sq.ft
<p>Total Load / Weight of Water = Minimum Depth of Foundation</p> <p>$125 / 62.4 = 2\text{ ft}$</p> <p>Since the water bottle foundation contains a lot of voids between bottles that do not contribute to buoyancy, a foundation depth of 39" was applied</p>	

7.17. Calculations for the depth of the water bottle foundation

ferrocement in the LIFT house in order to reduce the risk of cracking and increase the resistance to water penetration. The ferrocement foundation is 14ft by 10ft with ribs of reinforced concrete for added strength during floods. Once the foundation was cured after 21 days, the bamboo columns were inserted into the foundation through slots created by reinforcing rods left in the foundation. This connection between the foundation and bamboo structure was designed to be flexible in order to avoid concentrated stress on the ferrocement structure. Even though the dead load of the ferrocement foundation is heavier than the water bottle foundation, the entire airspace within the walls of the structure is activated during buoyancy, whereas the water bottle foundation consists of many air gaps that do not function in providing buoyancy.

The foundation designed with bamboo and water bottles is an innovative solution, inspired by junk raft construction, that is inexpensive and beneficial to the environment and additionally has the potential of creating employment opportunities for used bottle collectors if applied to a larger scale. The majority of this foundation was completed by unskilled volunteers. The 8000 used water bottles were collected from the local Westin™ hotel. These bottles were cleaned and caps tightly closed in preparation for use in the foundation. Nylon net was used around the foundation to keep the bottles from protruding out of the frame. A series of EPS (Expanded Polystyrene) foam boards were used as separators within the bamboo frame foundation. Once the water bottles were stacked, a waterproof membrane, locally known as “tripal”, was laid on top before the floor joists were fastened. This was done in order to stop moisture from traveling into the dwelling.

September, 2009

Mrs. Shafi had arranged a social worker to take Dyutee and me to two baste settlements within the city. This was a concern to my parents since all three of us were women entering a world that was unknown to all of us. The media has fuelled the general perception that bastees are the breeding grounds of criminals. I myself was a little hesitant to enter the bastees without a male companion. The driver of our car dropped us within walking distance of the first baste since it was not accessible by car. Korail was the largest baste in the city, with approximately 100,000 people in 90 acres of government owned land. Two of us walked closely behind our guide as she found her way through the maze-like paths. Spontaneous growth of the dwellings created narrow paths for accessibility, all unplanned, yet which seemed to function as the main circulation space flanked by commercial areas.

I walked into the baste with a number of preconceived notions about what to expect; the garbage, the smell, the hungry faces. To my surprise I saw a dynamic community with a loud and vibrant atmosphere. The area was not as dirty as I had expected. Everyone

was busy at work, glancing at us as we passed by. It was obvious we did not belong, and it gave everyone a reason to stare. The guide explained that NGO members and foreign researchers often visit these settlements now, so the residents are not so surprised to see outsiders coming by to talk to them. We walked fairly quickly through the paths and came to a large square, an open space left for residents to use how they like. The guide explained that this space was left open by the residents so that children can play and they can hold community events and prayers. I expected nothing like this; it was as if the residents were planning a community rather than the chaos that everyone perceived bastees to be. All around the square were large retail



7.18. A corrugated tin house in Karail baste

stores and other commercial spaces; we were at the heart of the basteer. I told the guide to take me into some homes so I could talk to residents.

We entered the narrow paths once again, stopping to talk to residents and asking them questions. I was curious to know their financial situation, how much they paid for services, and what kind of lifestyles they led. It was a pleasure to talk to these families. They were kind in inviting us into their homes and answering all our questions. Most of them asked me to sit in their home and offered me food. One family of four refused to let me go until I had entered their home and sat with them. In order to avoid hurting their feelings, I entered their home and sat on their bed, which also functioned as a couch, and asked them about their hardships. The house



7.19. Dwellings on stilts in Raiyer Bazaar basteer

was perched on stilts over the waters of Gulshan Lake. A small boy ran into the room with food and drinks in his hands which he was sent to buy for us. I was very touched by this gesture; a family struggling with poverty was more concerned about being a polite host. This side of the basteer was the most prone to flooding. During severe floods the families lost everything, including their homes. They explained their pain in rebuilding their lives, which only made their financial situation worse. The children went to school, and everyone was employed. Then why I asked, live in these conditions? They all had one answer, "Where else would I live?" They couldn't afford the high rents of regular housing, and so resorted to these illegal settlements that were constructed during the 1970s. There were houses of different standards, from the very temporary to permanent brick structures, but all had the same concern about tenure security and flooding.

Next I requested to see a basteer more at risk of flood devastation. The guide took us to the south east part of the city in Raiyer Bazaar, a basteer of over 95,900 residents mostly built on stilts along the river. The living conditions were of a much lower standard than the Karail basteer. The houses were one room bamboo dwellings where the

family performed all daily activities, including cooking. Access to water was located at a central area which all the families shared. These houses were far less private with 4-5 families sharing one latrine than the Karail baste. The Raiyer Bazaar baste residents pay rent to a third party who has an illegal hold on the land and allows the baste to exist. I was very sure the existence of this baste was politically motivated.

Visiting both bastes gave me a great insight into the lives of the residents. Overall I was surprised at the living conditions, which surpassed my expectations. The bastes lacked all adequate services, yet I did not see chaos. I saw communities that lacked opportunities. I met one woman in the Karail baste who said she spent over 150,000TK (approximately \$2,300 CAD) on her house and still had no tenure security. Most people I met made over 5000TK (approximately \$77 CAD) and were willing to spend over 1500TK (approximately \$23 CAD) on tenure costs. I was sure my design would address many of their problems and provide them with an affordable solution. However, just to be sure, I visited a number of other smaller baste communities to get a more thorough understanding.

Summary of Services in Karail and Raiyer Bazar Baste:

Electrical lines were illegally pulled from the city grid by third parties who took monthly payments from baste residents. The average monthly payment for each light fixture was 100TK (\$1.5 CAD), and higher for fans and television connections. The average family spent approximately 500TK (\$8 CAD) per month on electricity. Water was accessed through deep tube wells which were installed by various NGOs. A monthly repayment plan was set up for residents where applicable, or residents paid for water per bucket. Neither bastes I visited had access to a gas supply and so resorted to communal wood burning kitchens that were shared by 4-5 families in the Karail baste, and individual stoves inside the dwellings in the Raiyer Bazaar baste.



7.20. Bamboo dwelling on stilts beside a water body

CHAPTER 8.0 THE CONSTRUCTION

November, 2009

I came back to Canada at the end of September to develop the drawings in detail in order to return to Bangladesh in November and begin construction. As I finalized the last details of the LIFT design I kept in constant contact with my local engineers and staff from HBRI to ensure the team was ready to start construction once I landed in Dhaka again. The construction company ABCI Real Estate had volunteered their drafting staff, a site engineer, and a site supervisor for the duration of the LIFT project. Their support was invaluable to me since I had very limited knowledge of the local construction industry. With no prior construction experience I knew I was beginning a steep learning curve, but ironically everyone in Bangladesh assumed I was there to teach them new ways of building.



8.0. Soil test conducted on site



8.1. Excavation for the LIFT house service spine

GROUND FLOOR PLAN

3/16" = 1'0"

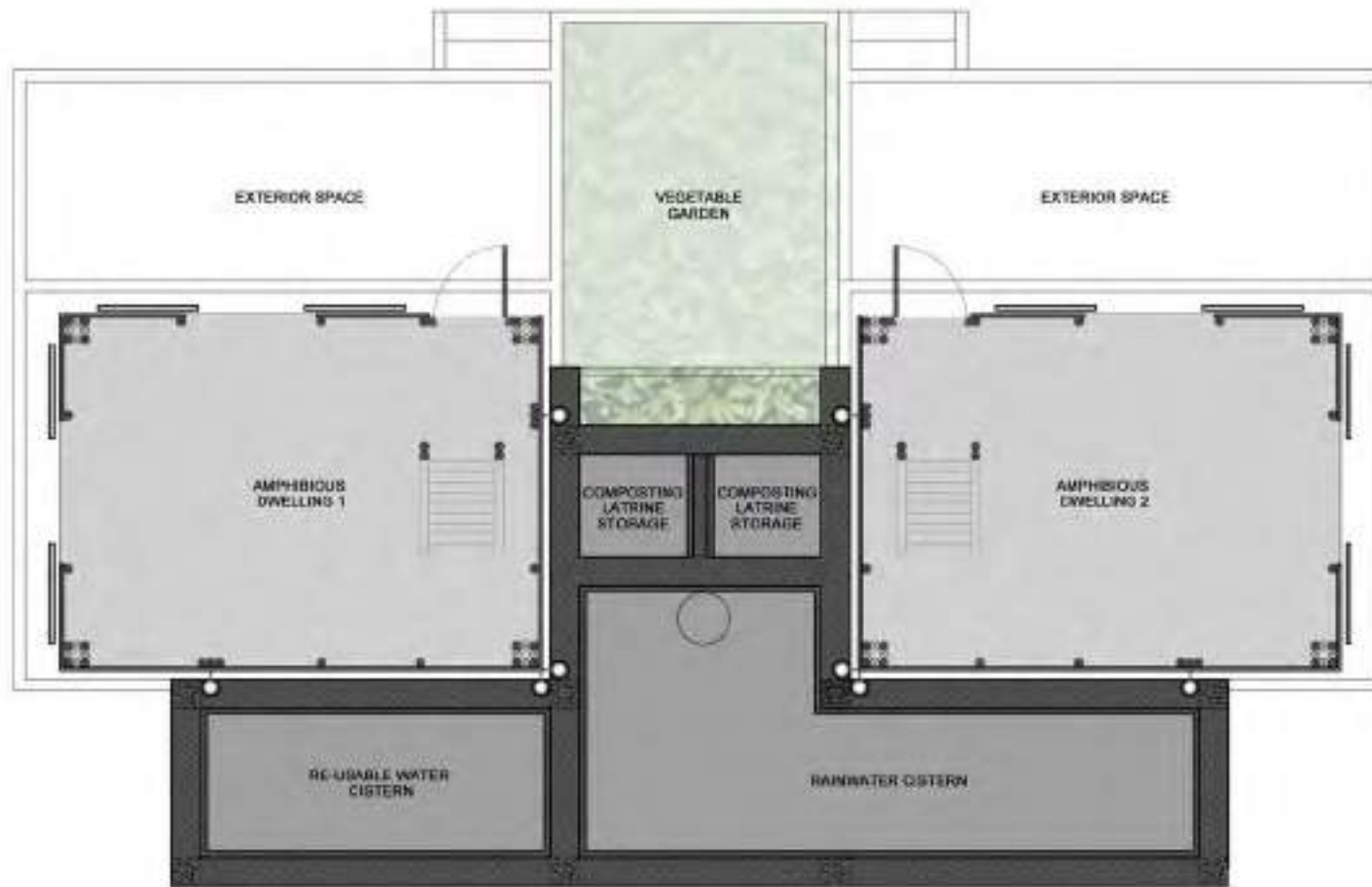

■ Interior Space of amphibious dwelling

■ Interior Spaces of the Service Spine

SECOND FLOOR PLAN

3/16" = 1'0"

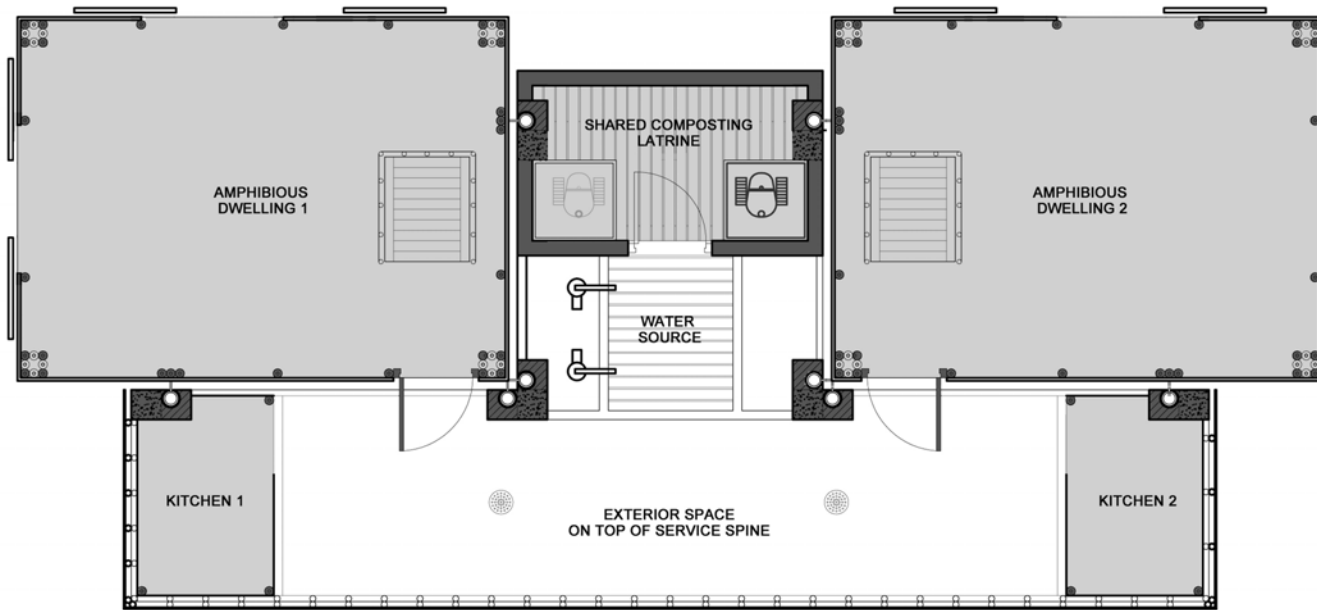

Interior Space of amphibious dwellings, kitchens and shared latrine

FOUNDATION LAYOUT IN SERVICE SPINE

3/16" = 1'0"

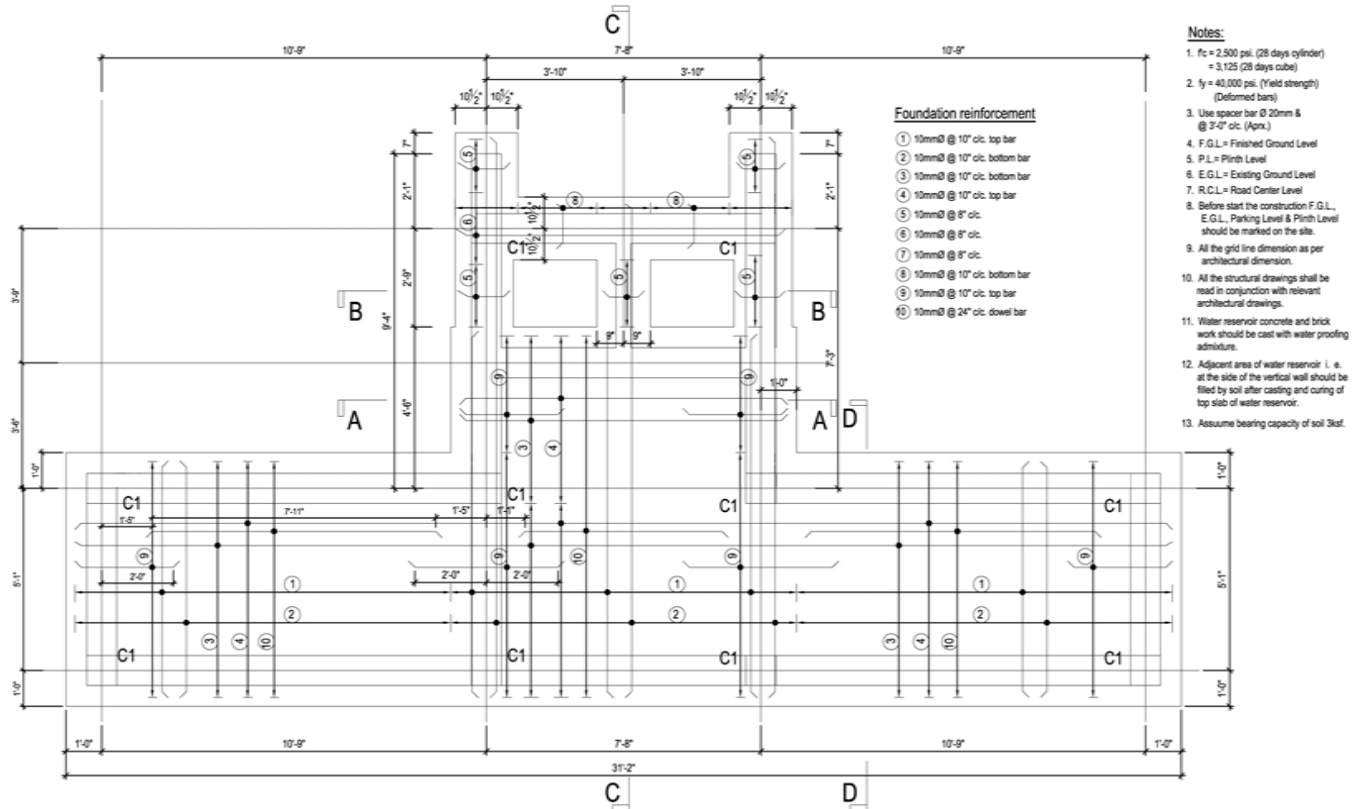

8.4. Foundation Layout in Service Spine

PLAN OF TOP CONCRETE SLAB IN SERVICE SPINE
 3/16" = 1'0"

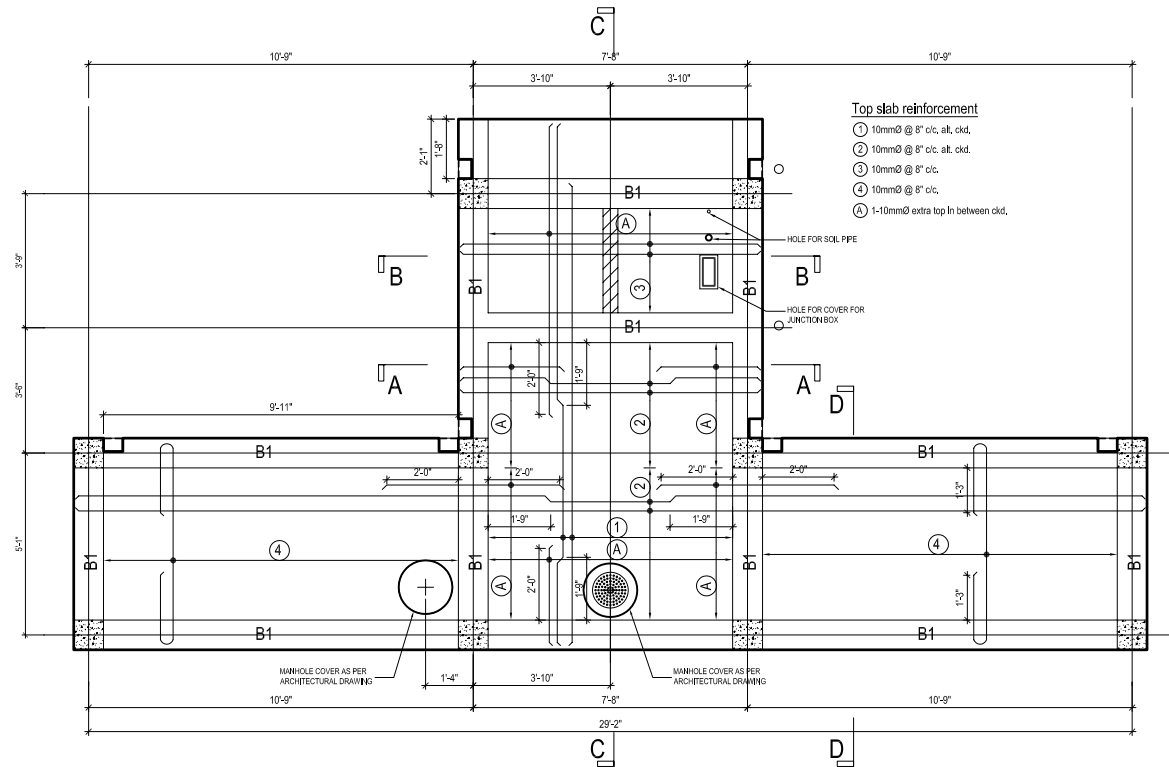

8.5. Plan of top concrete slab in Service Spine

LINTEL LAYOUT PLAN FOR SERVICE SPINE

3/16" = 1'0"

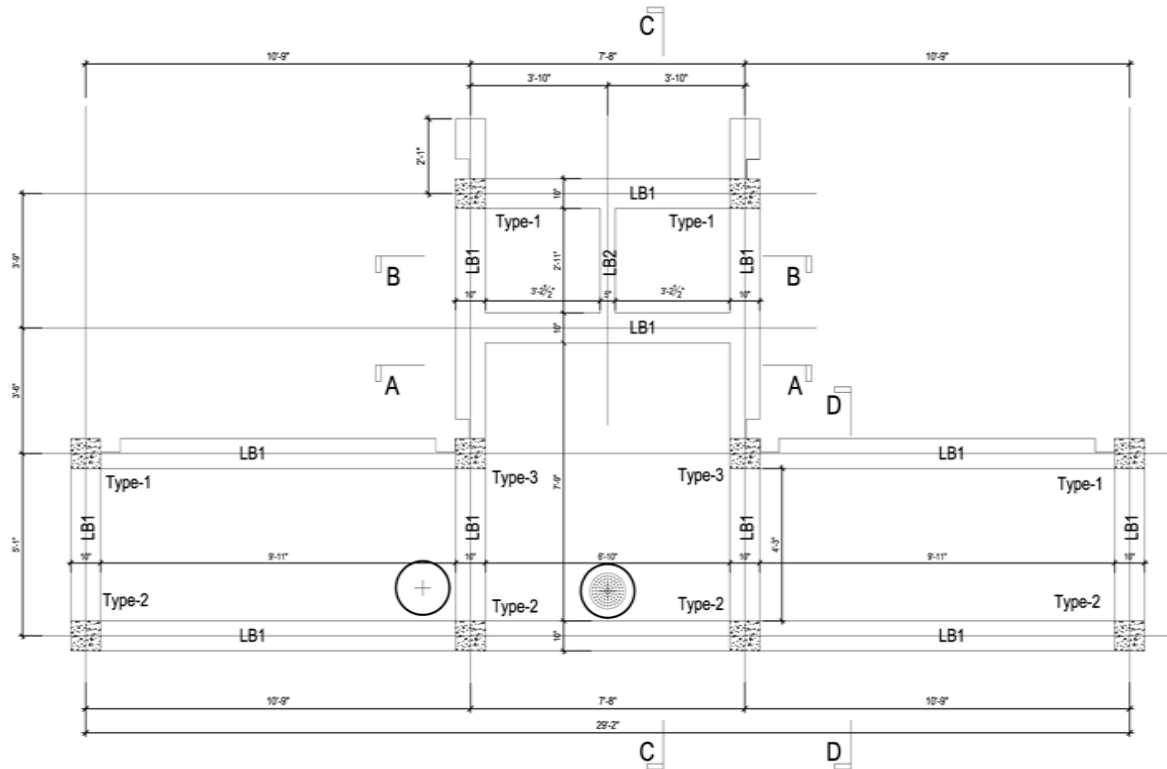

8.6. Lintel layout plan for Service Spine

COLUMN AND LINTEL DETAILS

3/16" = 1'0"

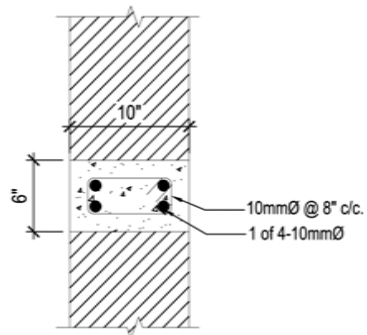

LINTEL SECTION (LB-1)

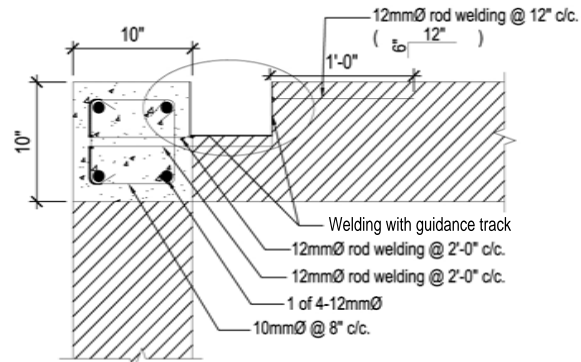

COLUMN SECTION 1-1 (Type-1)

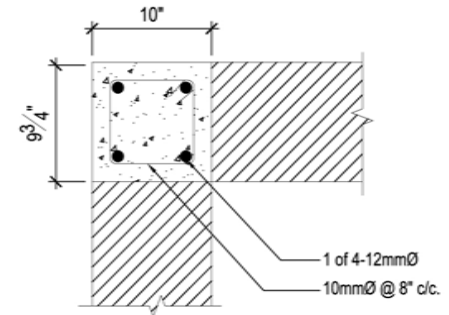

COLUMN SECTION (Type-2)

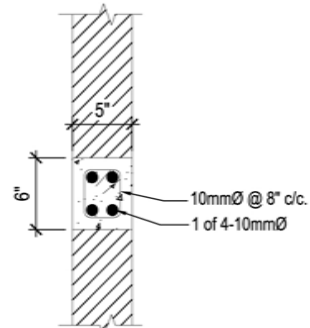

LINTEL SECTION (LB-2)

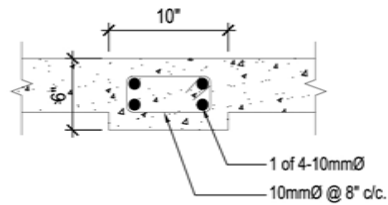

BEAM SECTION LB1/B1

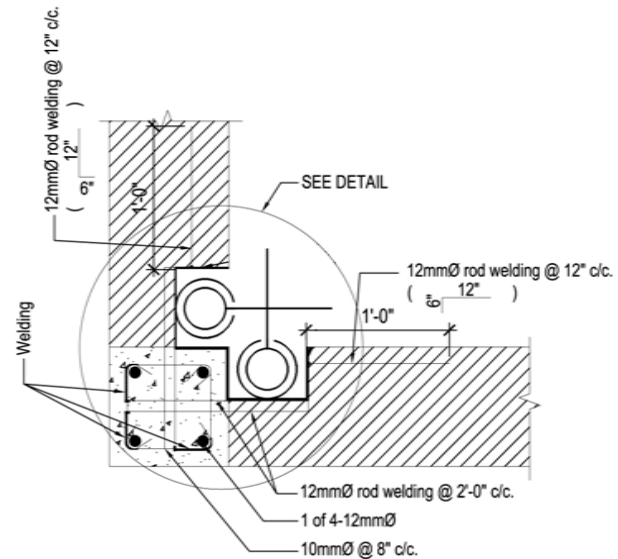

COLUMN SECTION (Type-3)

TYPICAL CONCRETE COLUMN SECTIONS

3/16" = 1'0"

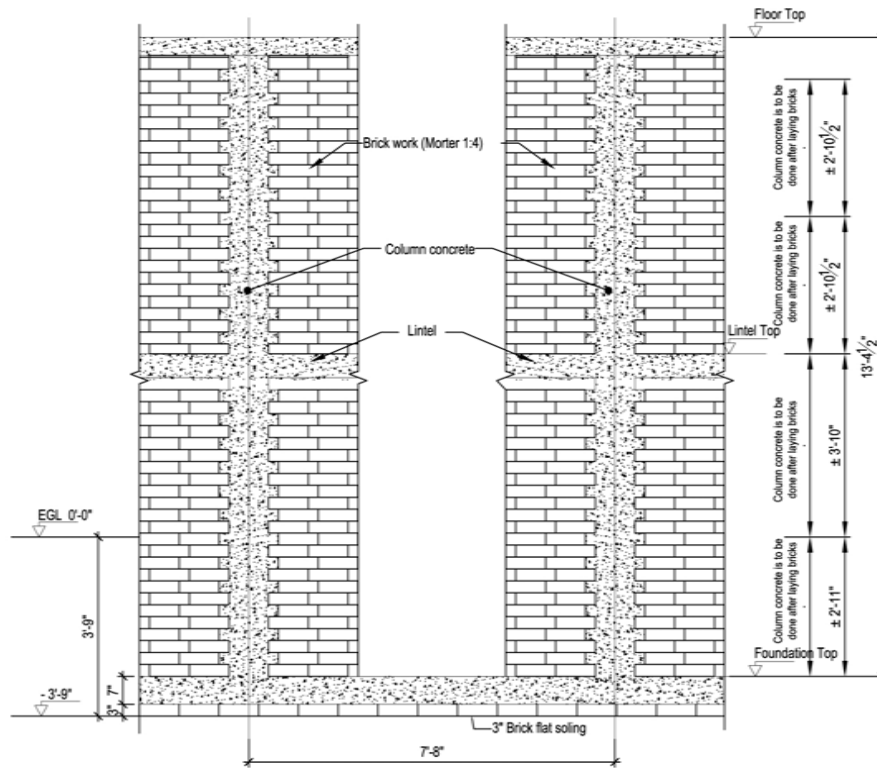

SECTION SHOWING BONDING DETAIL OF CONCRETE COLUMNS WITH THE BRICK WALL

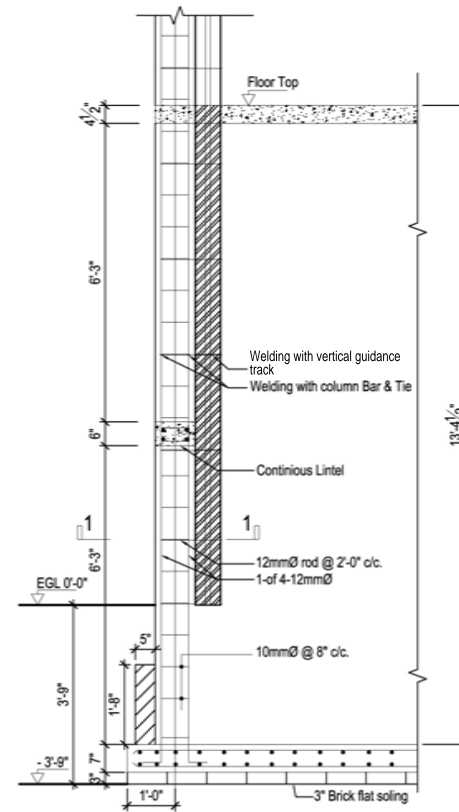

TYPICAL COLUMN SECTION WITH STEEL CHANNEL

SERVICE SPINE SECTIONS

3/16" = 1'0"

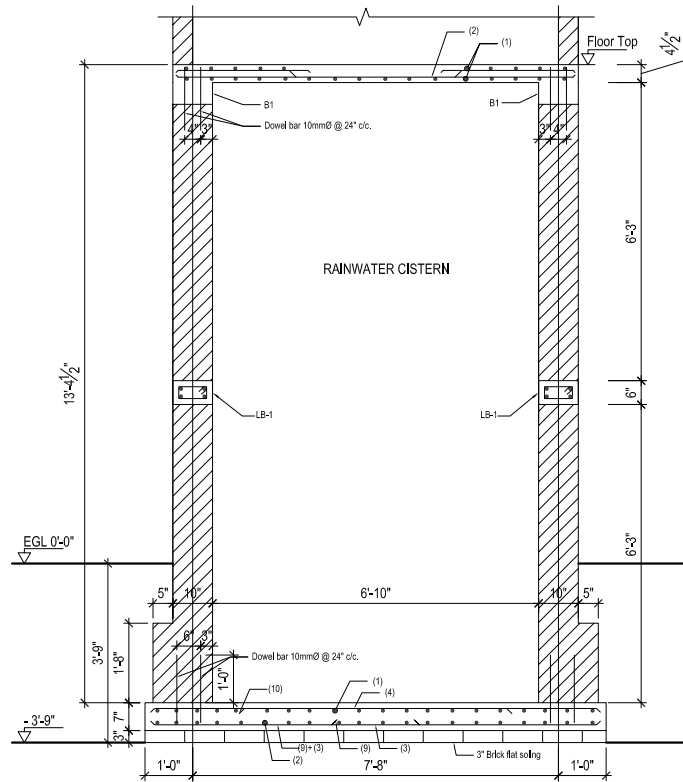

SECTION A

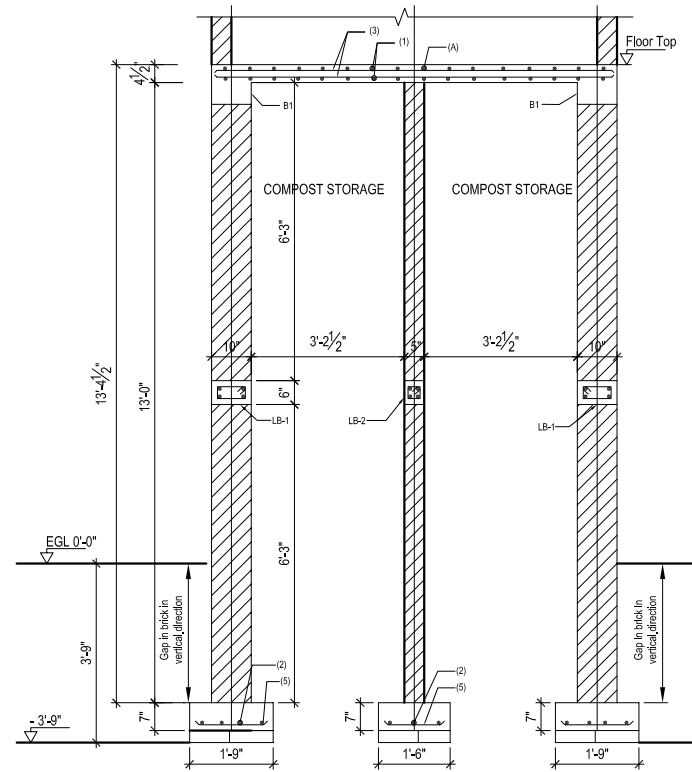

SECTION B

8.9. Sections A and B

SECTION C
 3/16" = 1'0"

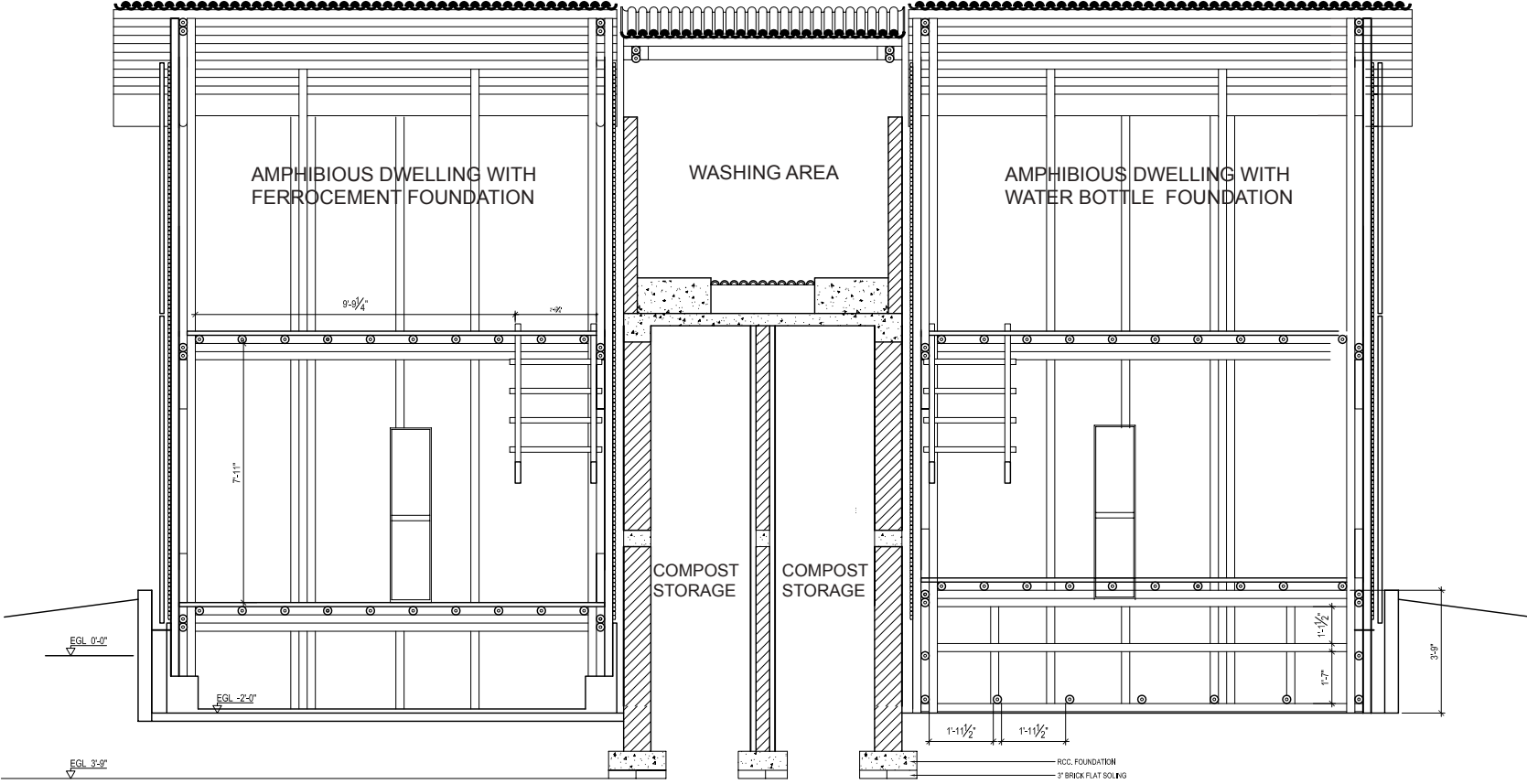

8.10. Section C

SECTION D
 3/16" = 1'0"

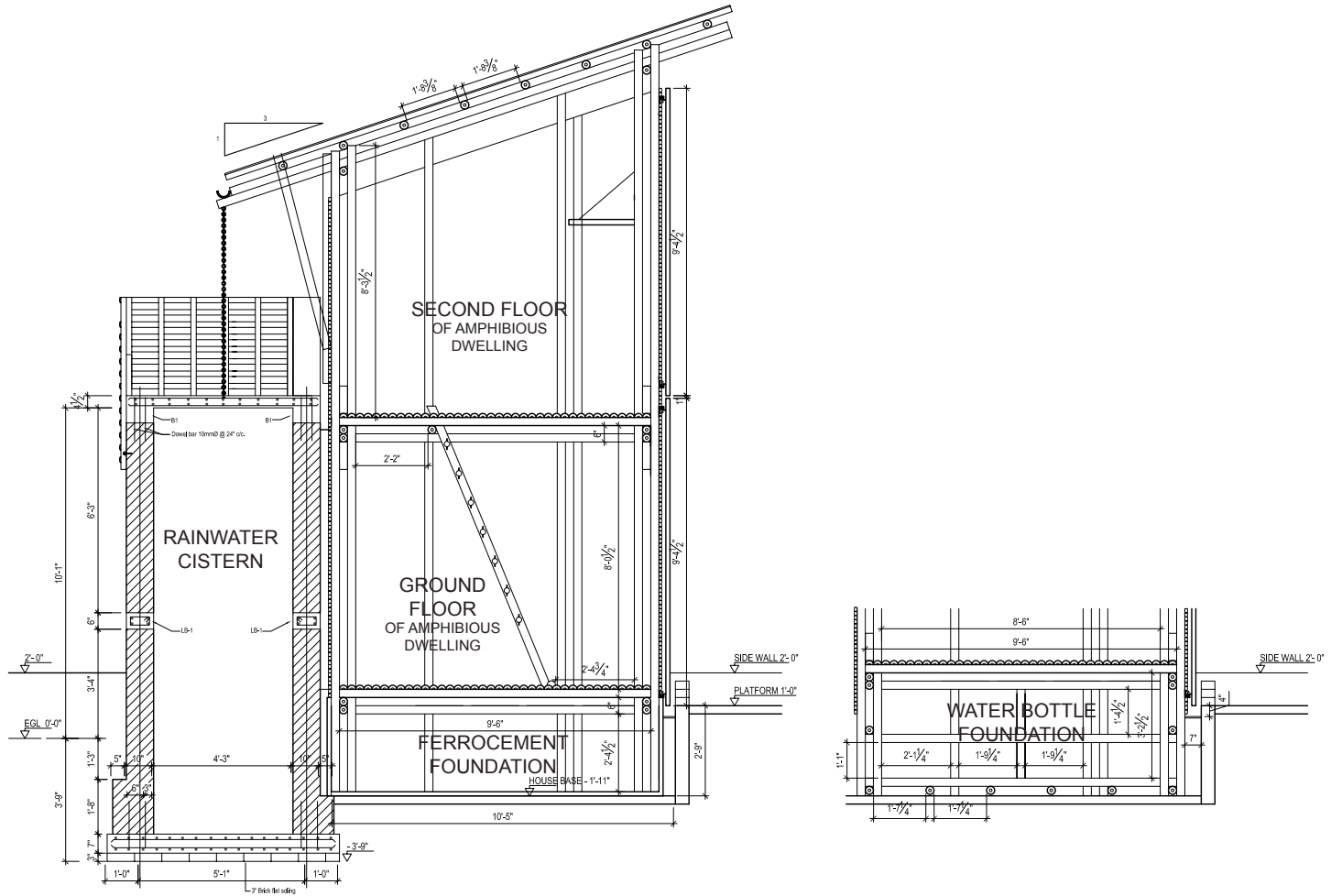

8.11. Section D

SIDE ELEVATION
 3/16" = 1'0"

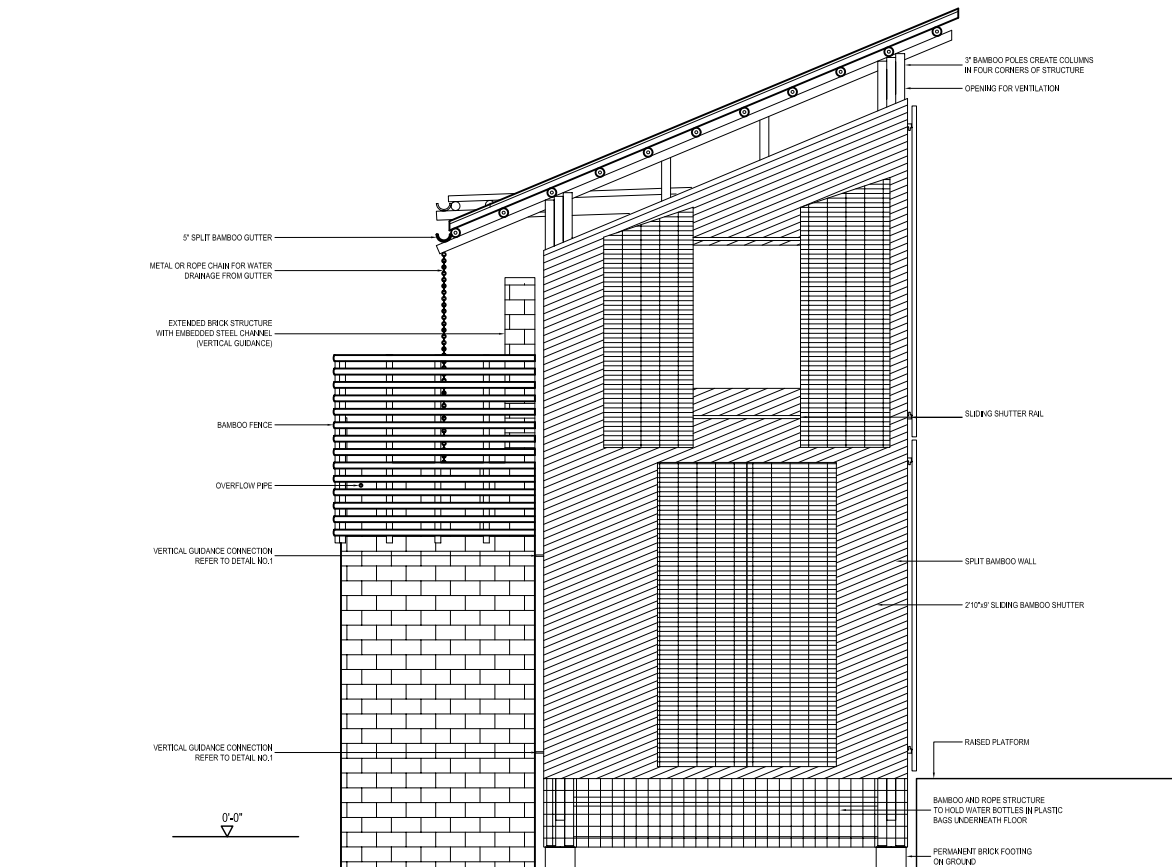

8.12. Side Elevation

FRONT ELEVATION

3/16" = 1'0"

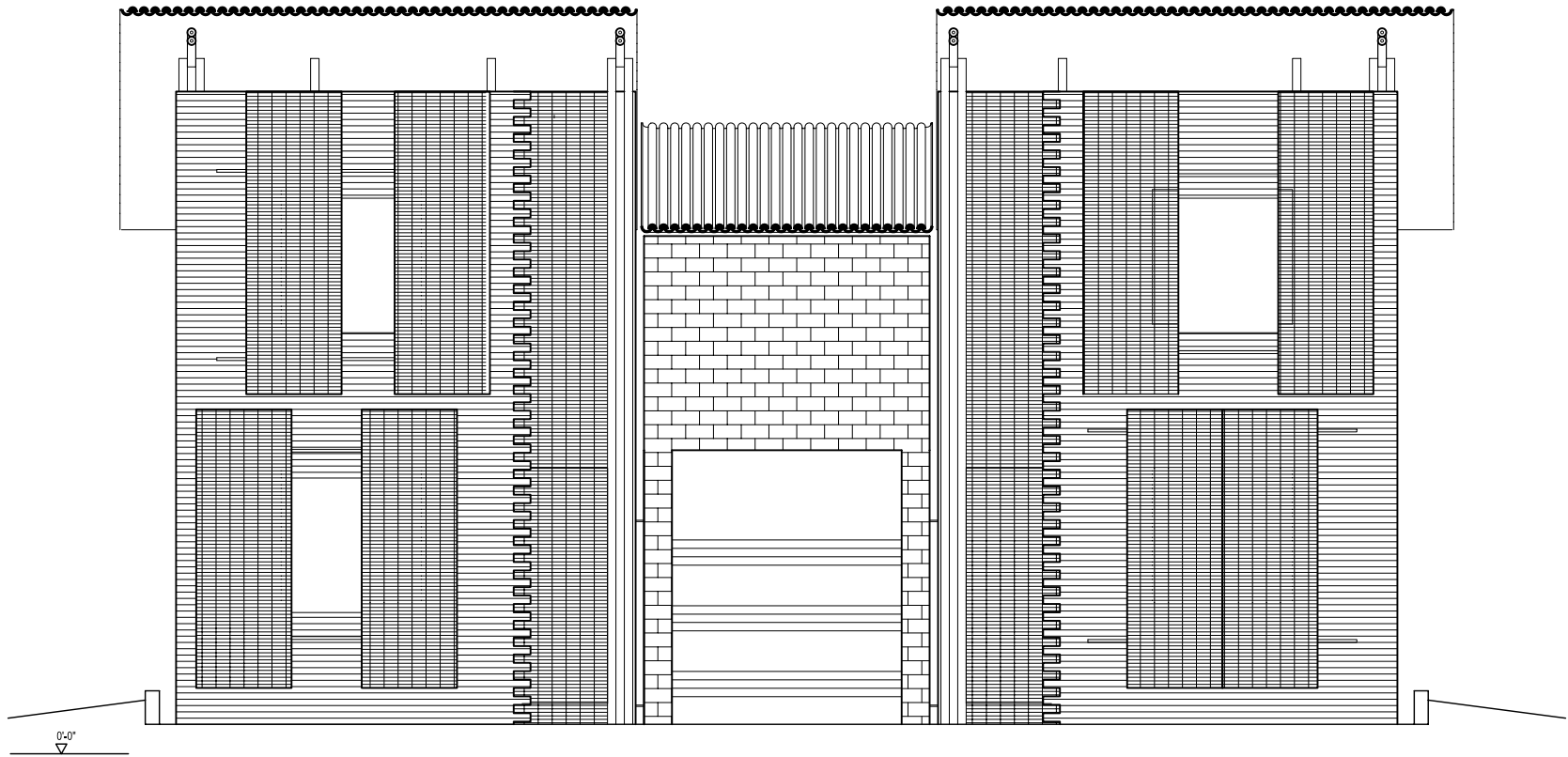

8.13. Front Elevation

DAY 1 - 5

November 10th - 16th

The first day on site was the morning of November 10th. I visited the site with my site engineer, Mr. Azad, and contractor to meet and coordinate final details with HBRI engineers. I was very excited to finally begin excavation. However, after sitting down with the team I realized there were concerns for the security in the chosen site due to surrounding bastees and I was told we would need to change the location of the building. This came as a surprise to me on the day I thought we were ready to start. I was very hesitant to change location due to security threats. Since they are the people my design wants to serve, I wanted the project as close to them as possible. In my conversations with the Director of HBRI, he explained the history of the HBRI bastee. Despite the fact that HBRI is a government property with boundary walls, they could not stop bastee dwellers from illegally taking over a large portion of the land. HBRI initiated one eviction without a resettlement program. The bastee was destroyed, but residents eventually returned and made a larger bastee. Since then the two groups have existed with a strained relationship, where a constant threat of evictions is communicated to the bastee residents. This fuels anger amongst the community. The start of a new project near their claimed land was a risk HBRI was not willing to take. Therefore, with



8.14. Beginning of excavation



8.15. Workers struggling to pump water out of the excavated area



8.16. Workers excavating the site manually

regret, we decided on a new location. Since the new location was in close proximity to a permanent water body, the soil load bearing capacity was questioned. The engineers suggested a soil test to ensure the foundation design was correct. Even before I began work, the construction was delayed.

The soil test was conducted on November 10th at which point we put down markers for the project boundary. It was a beautiful day; the sun was beaming and it felt like the perfect day to begin work. I was restless to begin because I had limited time in Dhaka and had to ensure that we moved on schedule. I had been warned by many professionals in the industry that



8.17. Excavators using bamboo baskets to move the soil



8.18. Water being pumped out of the excavated area

construction deadlines are hardly met in the city; time was not a crucial element in construction as it is in North America. The cost of labour is a fraction of what it costs in North America - perhaps that is why a few extra days or months added to the schedule is a small challenge in Dhaka. I was surrounded by men waiting for my instructions. It was a beginning to the countless decisions I had to make on site when simply relying on the drawings was not enough. One of the men conducting the soil test approached me and Mr. Azad to inform us that the soil quality was very good. He said it was "red soil", which meant there was high clay content in the soil. This was great news for my structural engineer, but Mr. Azad frowned and explained that

it would be very difficult to work with this soil, which becomes very slippery when in contact with water due to the clay content. He clarified what I was afraid to hear, “the excavation will take longer than we scheduled”. The contractor informed me that he would be ready to begin excavations the next day; that was great news.

The next day I reached the site at noon, which was approximately 10km from my accommodation, but took nearly 45 min due to traffic conditions. As construction continued I experimented traveling to the site at different times in the day to find the point at which I wasted the least amount of time in traffic. At my arrival, the site supervisor updated me on the progress. Even though it was just a hole in the ground, to me it was the most satisfying image to see the project finally break ground.

A team of 10 excavators was working at the same time, but the speed remained very slow since all the work was done manually. Automated excavators were expensive and only used in large buildings in Dhaka, and so were deemed unnecessary by the contractor for this work. The soil was cut by shovels, raised on the workers’ heads in bamboo baskets, and dumped to a specified location. For 3 days I watched the soil being taken out inch by inch, until we



8.19. Excavators faced difficulty in continuing work with the slippery soil



8.20. Shutters placed around the perimeter in preparation for concrete pour



8.21. Brick soiling prepared for concrete slab

reached a point when we could no longer control the water seeping up. In a normal soil condition, pumping out the water would be sufficient to allow workers to continue; however as Mr. Azad had pointed out to me earlier, it was very difficult to work with the “red soil” type and so we made a decision to stop excavations and lay the foundation 1ft less in depth than the design.

Once the excavation was complete, shutter boards were laid around the perimeter of the excavated area to begin soiling. This layer of bricks was put as the bottom layer of the foundation slab to avoid pouring the concrete directly on the wet soil.

DAY 6 - 10

November 17th – 21st, 2009

Materials were carried onto the site overnight in large trucks. These vehicles were not allowed to carry loads during the day in order to avoid further aggravating the traffic conditions. I was grateful for my site engineer who handled all purchase and delivery of materials. Watching him fight on the phone regarding on time delivery was difficult enough; I am sure it would have been impossible to get materials on site on time if I, an outsider, without the appropriate networks, had to organize everything.

I hired a guard from a security company to protect the site overnight and supervise the material drop-offs. We were warned by HBRI staff of various accounts of material theft by surrounding bastee residents.

On the first night of duty the bastee residents made noises throughout the night to scare the security guard. Frightened by the prank, he refused to come the next night. We hired a different security guard for the following day only to find out that he too was frightened by the locals. The site supervisor, Mr. Atyar, was provided with accommodation nearby to keep an eye on the premises until we found a permanent replacement. At last, the HBRI cook, who lived beside the bastee, became our security guard for the entire project. He was an appropriate



8.22. Cement bags delivered in small amounts to avoid storage on site



8.23. Reinforcing bars prepared for concrete slab



8.24. Reinforcement laid for concrete slab



8.25. HBRI's concrete mixture used to pour floor slab of the service spine

replacement because of his knowledge and experience of living in the area. Unlike outsiders, he did not fear the bastee residents and knew them well.

Once the excavated area was ready, the lattice of steel reinforcement was laid with brick spacers in preparation for the bottom slab. Sudden rainfall had interrupted our goal of pouring the concrete so instead prepared steel rods for the next day's work.

The day of the concrete pour was very exciting. It was a bright hot day, and everyone was looking forward to the pour. In the local construction culture, it was customary to celebrate the first concrete pour. I only found this out after several hints from the workers throughout the day. We borrowed the concrete mixer from HBRI which made the process a lot faster than manual mixing. The structural engineer dropped by in the morning and suggested mixing a compound into the concrete mixture to set it at half the time. This was an added expense, but given the uncertain weather, we wanted the concrete to set quickly. As the concrete was mixed and quickly poured I made arrangements for a delivery of Bengali sweets to mark the occasion, which was very appreciated by the workers. A crowd formed around the concrete mixer. I was told the first slab of a construction project marks its beginning. "It will go very fast from here," declared Mr. Azad.





8.26. Panoramic photo of LIFT site with reinforcement bars for columns

And it did. Once the slab had set, the 15” perimeter wall was quickly laid. The dowels emerging from the slab were set into the wall to ensure a strong bond. I was content that it finally looked like a construction site, with a myriad of standing rods and layers of bricks on top of a concrete slab.

When Mr. Azad had asked me which bricks I wanted to use, I had chosen the least expensive option. Now that the 10” brick walls were rising I realized how unpleasant it looked. We decided to use one layer of the more expensive “ceramic bricks” on the façade of the service spine and use the “bangla bricks” on the inside. While the brick walls were under construction, a small team was prefabricating concrete lintels that would span the inside of the service spine for lateral support. These members would later be placed within the lintel band around the service spine before pouring the concrete.

Spaces within the brick walls were left with exposed reinforcing steel. They were later filled in with concrete to form the columns.

I prepared the holding tank for the chemical treatment of the bamboo by using concrete piles found on site and putting heavy plastic wraps to hold the diluted chemicals. A mixture of boric acid and Borax was diluted with water to break down the starch content inside the bamboo.



8.27. Worker pouring service spine floor slab



8.28. 15” perimeter wall with dowels for added strength



8.29. Walls of the service spine around the composting latrine storage pits



8.31. Concrete lintels



8.30. Concrete poured into gaps left for columns in the brick walls of the service spine



8.32. Service spine walls and columns for water cisterns completed halfway

Local engineers did not want to take responsibility for the buoyant foundations of the project. I found myself very frustrated in trying to design the foundations with no prior experience. It was very difficult to convince engineers like Mr. Selim that a house built on a foundation of used water bottles was realistic. There were no precedents in Bangladesh, I only knew about a few rafts that were built out of used plastic bottles I learned about in an amphibious course taught by Dr. English. I felt pressured to consider using a more traditional material, like concrete. It was crucial that I make a model to test the viability of the design and its live load capacity. We began by making a 3ft x 5ft bamboo structure, 2.5ft in depth. The joints were nailed and tied with plastic ropes. Immediately we realized that nylon was a better option due to its longer life and ease of tying. It was also apparent that bamboo needed to be pre-drilled in order to avoid splitting.

The structure was laced with rope to hold the water bottles together. A layer of wire mesh was applied on the top with a layer of split bamboo to hold the live load. Once all the collected bottles were cleaned and inserted into the structure it was placed in the water for testing. In the absence of a better alternative, we decided to have the workers walk onto the model to test its load capacity. Without anchorage and a rectangular surface on water, the model was prone to tipping. After eight men climbed onto the floating model, the men were thrown into the water.



8.33. Preparation of the holding tank for bamboo treatment



8.34. The start of the foundation models for testing



8.35. Water bottle foundation model



8.37. Workers testing the water bottle foundation model for live load capacity



8.36. Volunteer attaching ropes to encase the used water bottles in preparation for testing



8.38. Model tipping over

DAY 11 - 15

November 22nd – 26th, 2009

A second buoyant foundation model was constructed out of a bamboo frame, with wire mesh and plaster. I had only seen this method in a small model in the past and was hesitant to apply it to the LIFT house without a proper test. This method required a significant amount of time and manual labour to make it water tight. A bamboo frame, similar to the water bottle structure, was first made. Then a wire mesh was wrapped around the structure and covered with a porous cotton cloth. This gave it form to which layers of a cement sand mixture were brushed on by hand on both the inside and outside. Once the layer was dry, another layer was added until we were satisfied the model was ready for testing.

Similar to the water bottle foundation model, the structure was put in water and workers sat on top of it to test how much load the structure could support and still stay buoyant. As expected, this model performed better than the water bottle model, since the water tight compartments providing buoyancy are considerably less due to the voids between the water bottles. After a successful testing period both structures were left on water to see if there was any slow leakage. The first foundation with water bottles remained the same; however, the second foundation had a leak in a corner. The rectangular



8.39. Second foundation model wrapped in metal wire and cotton cloth



8.40. Inspection of the second foundation model before testing



8.41. Bamboo floor built for volunteers to be able to sit on model



8.42. Live load test showed greater capacity than the water bottle foundation in similar size

structure received increased water pressure at the corners which led to the failure. Yet, more importantly it was discovered that human errors, such as the varying thickness in application of the plaster and not waiting long enough to dry each layer, were the main reasons the structure failed to keep water out. Given the difficulty in making a successful small model, I decided not to apply this method to the LIFT house. Instead, I decided to use a technology that was similar but was heavier and more costly. It had been tested in floating structures in the past. Ferrocement structures have been made and applied in Dhaka by the HBRI who promote it as a lighter weight, waterproof alternative to concrete. This was the ideal choice because it accomplished the project goals and was possible to construct with available local skills.

The bamboo market was situated very close to the site. I went with Mr. Atyar, the site supervisor, to pick out the bamboo we wanted for the project. Thousands of bamboo poles surrounded us as we walked deeper and deeper into the storage area. I specified what we wanted, straight, long and 3" in diameter. Of course, I knew a natural material like bamboo was very hard to find in consistent shapes and sizes, but I still had to try to get the best possible selection in order to maintain the aesthetic value of the project. It was also

important to buy bamboo of a similar diameter to avoid complications during the connections. I was very particular about the choices and rejected almost all the ones they showed me. The stacked bamboo on racks are very deceiving, they look long and straight until they are separated. After spending an hour with very little success I returned to the construction site and gave the duty of selecting the bamboo to Mr. Atyar. In the next few days, he traveled all over Dhaka to find the best selection of Boruck, Muli and Jawa bamboo.

Once the bamboo was delivered, two holes were drilled on every joint to allow the treatment to pass through the interior. It was then cut to size and dropped into the chemical mixture. The excess bamboo was stored in the pond which is the indigenous method of treating bamboo.

The structural bamboo team arrived from Dinajpur. They had acquired valuable skills in bamboo construction from their villages where a few structures were recently built out of bamboo, the METI School being one of them. It was their first visit to the city and they were very reluctant to make the trip. After many days of convincing, I succeeded in bringing them to Dhaka. I was confident in their skills and felt we could learn from each other through the construction of the LIFT house. I arranged their accommodation close to the site and appointed someone to take care of their



8.43. Bamboo delivery on a “Thelagari”, a vehicle made of bamboo, wood, and two tires pulled by two men



8.44. Bamboo drilled at every joint by a volunteer



8.45. Bamboo cut by hand saws



8.47. Chemical treatment of the bamboo before installment



8.46. Bamboo treated in the traditional method of submerging in a water body



8.48. Worker bending dowels

every need. Unlike my other workers, these 4 bamboo workers were artisans. They had great respect for their craft and worked harder than any of my other workers.

As the bamboo team prepared and treated the bamboo, the rest of the workers were busy at work finishing the service spine. A small team bent, cut, and prepared the steel rods, and another mixed concrete for the columns and lintels, and the rest laid bricks.

The LIFT house was now visible from a distance and created a lot of interest amongst the surrounding bastees. A sense of bitterness was present amongst the bastees; perhaps they feared the construction of this building was a sign their evictions were in the near future. I reassured them there was nothing to worry about and in fact the LIFT house was being built for people like them. As I explained what the LIFT house could do, a sense of wonder and disbelief overcame them every time.

The holiday of Eid was a big celebration for the country and this meant all Muslim workers would be away for 10 days. I collected as many Hindu workers as I could for that length of time and decided to do a little traveling myself. I was in search of expert bamboo weavers. My search took me to the birthplace of my parents, a village in Nobabgonj, where I was lucky to find a team of artisans who were capable of doing all the bamboo finishes.



8.49. Lintels for lateral support inside the water cisterns in the service spine



8.50. Shutters around the corner concrete columns in the service spine



8.51. Service spine



8.53. The LIFT house across the pond



8.52. Ceramic bricks installed in the visible sections above the "Bangla" bricks



8.54. Workers laying brick walls above the lintel band

DAY 20 - 25

December 1st – December 6th, 2009

I came back to the site after the holidays to find the structure of the service spine completed, with the top slab poured. The two excavations for the bamboo dwellings were started. This would create a holding tank for the foundations which could be filled with water to test their buoyancy. For the first time women from the local area were hired to move the soil. This again was a slow process but I did not mind this time because I was occupied with considerable work being done on the side.

The concrete columns that would hold the vertical guidance poles were still being poured to extend beyond the top slab to allow the house to move up. Though originally designed to be higher, an adjustment was made on site to make the columns extend no higher than 4 ft. Since HBRI is located on high ground and has not experienced severe flooding, it was therefore decided that 4ft columns would be enough to demonstrate the amphibious nature of the building and remain cost effective.



8.55. Excavation of the holding tank for the ferrocement foundation dwelling



8.56. Excavation of the holding tank for the water bottle foundation dwelling

DAY 26 - 30

December 7th – 11th, 2009

Once the excavations were complete, the two dug holes were laid with brick and then poured with concrete for an even base. Since the dwellings would be moving up and down, it was important to have a solid ground for the amphibious foundation to sit on thus avoiding structural problems. The sides of the excavated area were strengthened with a low brick wall to avoid soil movement.

A team of ferrocement workers was finishing the interior of the water cisterns. Since a brick wall is porous, layers of ferrocement were used to restrict moisture penetration which could lead to structural failure of the walls. First, wire mesh was hooked onto the brick wall, then two layers of cement and sand mixture were applied. This was a difficult procedure because each cistern was 13 ft in height with one manhole access and a ladder. Due to the height of the cisterns, the work was done in two sections; first the bottom half was completed, then the top half.

The month of December was very cold to be working in the morning and evening hours, which led to shorter, less productive work days on site. Most of the workers had returned from holidays and I was trying very hard to pick up speed in order to install the bamboo portions of the project.



8.57. Layer of concrete on brick soiling on the bottom of the water bottle foundation dwelling holding tank



8.58. Side walls for water bottle foundation dwelling holding tank

DAY 31 - 35

December 12th – 16th, 2009

The reinforcement frame for the ferrocement foundation was started on ground away from the service spine due to space restrictions. It came to our attention that the ferrocement needed to be added from both the inside and outside of the foundation. This would be impossible to do on location as there was only a 3" gap between the dwelling and the service spine. We decided that the construction of the foundation would take place 2 ft away from the service spine and once the concrete was cured, it would be floated into place. Therefore the low walls of the holding tank in which the foundation would sit were not yet constructed, in order to provide more space for the construction of the foundation.

Once the reinforcement frame was complete it was moved into the excavated area where layers of the cement and sand mixture were applied and packed with the help of shutters that created molds for the concrete ribs. Halfway through the process, I noticed the dimensions of the foundation were not accurate, with a difference of 1.5" on every side. After many heated discussions with the workers, who did not pay attention to the drawings, and the HBRI site engineer, who was put in charge of the ferrocement foundation, we came to a decision that it was too late to make amendments to the foundation, and the bamboo dwelling must be adjusted to fit.



8.59. Ferrocement foundation frame of steel rods and wire mesh



8.60. Ferrocement foundation structural frame



8.61. Ferrocement foundation placed into holding tank



8.63. Cement mixture laid on both the outside and inside face of the foundation



8.62. Cement mixture poured into frame and compressed



8.64. Shutters laid for concrete ribs

HBRI had done numerous floating structures with ferrocement in the past, two of which I saw in Dhaka. I had requested the engineer involved with these projects to design the ferrocement foundation for the LIFT house. After a few days of pushing paper to the right people, I finally got an acceptance from HBRI. I found it very difficult to convince other engineers to help me and it was a great relief that Mr Wahed could take on this project. It seemed that my project was a liability for these professionals because they were not comfortable with amphibious structures. Even Mr. Wahed did a design using excess material and reinforcement to overcompensate for risks, which I now understood was good engineering practice for new applications, but was frustrating at that time. Mr. Azad and I were aware that the foundation was costing more than it needed to, but we built according to the drawings to avoid any risks.

After treatment, the bamboo were left to dry for a few days, making the members significantly lighter. The joints (nodes) of the bamboo were peeled to ensure a smooth finish that is easier to join and aesthetically pleasing. What started off as a deep green colour was now becoming yellow as it dried.

Mr. Azad and Mr. Atyar usually communicated my instructions to the construction workers. However, the bamboo workers were working with me directly since I could not find an



8.65. Bamboo being dried after treatment



8.66. Bamboo shaved to reveal smoother finish



8.67. Bamboo cut into usable pieces



8.68. Stick model of bamboo dwelling to communicate to bamboo workers



8.69. Bamboo roof sample



8.70. Bamboo weaving pattern sample

engineer who had knowledge of working with bamboo. This was the beginning of an intense journey of building the two dwellings. My knowledge came from books and a few examples I had seen of bamboo work. However, more than experience, one needs imagination when building with bamboo. I learned to trust my instincts and the knowledge of my bamboo team, and together we were able to overcome every problem we encountered, and there were many. Every piece of bamboo is unique in its form and dimensions, which made it a challenge to create joints. I could hardly rely on drawings, and had to carry my laptop on site everyday to update drawings and perform calculations as the work progressed. I had to overlook and control every aspect of the construction since there were no standards to follow. On site, I would begin the day by drawing simple diagrams to communicate the construction details to Mr. Fotik who was a leader amongst the bamboo team, then supervise the day's work, leave them a diagram for the next morning's work, and return home to update drawings and calculate the next day's work. This was the only way we could work to ensure the design was adjusted as the decisions were made on site.

Once the bamboo finishes team arrived from Nobabgonj, we started making small models of the roof, and different weaving patterns to finalize the choices. I was very pleased with the unique roof design which was a traditional way of making roofs in hilly areas of Bangladesh.

DAY 36 - 40

December 17th – 21st, 2009

Columns and beams were made by attaching two, three or four bamboo pieces together with a wood clamp. The bamboo were placed in the clamps with temporary ties to hold the members in place. Once secured, the bamboo was predrilled and then inserted with a steel rod every 3-4ft on an angle to restrict the rod from popping out. Then a metal wire was wrapped and twisted in place around the metal rod insertions. I was pleasantly surprised at the strength and rigidity of the finished members.

As the bamboo members were being prepared, the toilet walls in the service spine and the plaster work inside the compost storage area was being completed. The dividing wall in the storage compartments was heavily plastered to avoid contamination of the active sewage with the composted manure. Once this was done, along with laying all the plumbing work, the front wall of the compost storage area was sealed with bricks.

The prefabricated steel vertical guidance tracks were a challenge to cut and install. The desired opening along the pipes caused the members to deflect. This required onsite work to fix the problems and straighten the openings manually.



8.71. Bamboo placed in wood clamps to straighten the bamboo before joining



8.72. Method of creating beams



8.73. Metal wires tied around steel rod insertion in bamboo beams



8.75. Grooves left in wall of the service spine to place vertical guidance tracks



8.74. Bamboo pre-drilled before inserting steel rod into columns



8.76. Straightening the opening in the steel vertical guidance tracks

DAY 41 - 45

December 22nd – 26st, 2009

As the ferrocement foundation was curing, we began work on the water bottle foundation for one of the dwellings. Since most of the members were ready to be installed, the work was completed very fast. First, the four columns were placed and secured by attaching the bottom beams. Then the top beams were placed to straighten the members as we began working on the foundation. The members were held in place by temporary ties and then drilled with a rod inserted at every connection. Nylon ropes were later used to tie every connection by hand.

All the bamboo in the foundation portion was pre-coated with a sealant for a longer life. Bamboo pegs were used instead of steel rods at the connections in the foundation where it will be exposed to water.

As the work on bamboo commenced, a shipment of used water bottles was received every few days from the Westin Hotel. A small team was assigned to clean these bottles and securely put tops on for use in the foundation.



8.77. Bamboo pegs made for joints that will be exposed to water



8.78. First column pulled into place



8.79. Bamboo columns carried to position



8.81. Connection of bamboo beam and column



8.80. Beams attached to columns by bamboo workers



8.82. Nylon tied around bamboo connection



8.83. Structural frame for water bottle foundation dwelling



8.84. Detail of column and beam connection



8.85. Installment of top beams



8.86. Mulli bamboo split into thin strips for weaving



8.88. Service spine finished and installment of first bamboo structure complete



8.87. Special blade used to split Mulli bamboo into thin strips



8.89. Used water bottles prepared for foundation by volunteers

DAY 46 - 50

December 27th – 31st, 2009

Jawa bamboo was split into six long parts and laid on the floor in two layers in opposite directions. This was one of the most time consuming procedures, but the finished product was beautiful. The foundation was being prepared for the water bottles by wrapping nylon net around the structural frame before the ground floor finish was applied.

The toilet and washing areas were plastered. Bamboo was cut and assembled for the railings. Metal rods had been left in the top slab of the service spine for attachment to the bamboo railings by pouring concrete into the bamboo void. After finishing the railings it was noticed that, while very



8.90. Jawa bamboo pieces layed in two layers for floors in dwelling





8.91. Bamboo frame with nylon net for water bottle foundation



8.92. Experiments with bamboo to use in various applications



8.93. Panoramic photo of the LIFT construction site

strong, the vertical railings moved slightly when pushed. In order for the residents to feel more secure, we decided to add metal clips to the bottom of the railings attached to the brick walls of the service spine.

The ferrocement foundation was finished and moved into position by pushing it into place during flotation. The four bamboo columns were inserted into place very carefully because the foundation was sensitive to cracking. Getting the columns in place was very difficult and required the entire team. While placing the last column some of the workers lost balance and the column slipped and fell over. After I recovered from my shock I realized no harm was done and we moved it back into place.

It was important to me that my workers were enjoying the project. We had spent a lot of time together, learning from each other, and I wanted to keep their energy up until the project was finished. This is why we had many team lunches where we hired a chef to cook on site and we all ate together. I provided them with t-shirts with the LIFT logo, which instantly made them feel like a family and resulted in their working much more closely from that point on.



8.94. Ferrocement foundation moved into position after curing



8.95. Bamboo mats woven for interior walls



8.96. Custom latrine made to divert urine



8.98. Installment of bamboo railings



8.97. Underside of second floor



8.99. Careful placement of bamboo column into ferrocement foundation



8.100. Beam placement in ferrocement foundation dwelling



8.102. Columns pulled in place on ferrocement foundation



8.101. Bamboo frame showing connections



8.103. Boundary wall for raised garden



8.104. View of LIFT house across the pond



8.106. Team lunch



8.105. Second bamboo frame under construction



8.107. Used water bottles inserted into foundation

DAY 51 - 55

January 1^t – 5th, 2010

The pointing of the bricks (cleaning the grout lines) seemed to have taken as long as it took to construct the walls. With the bulk of the work now done, the finishing work was taking longer than I had expected. My initial deadline of January 14th could not be met, and I had to push back my departure and the LIFT house inauguration to the 26th.

Installing the vertical guidance pipes and steel plates to the bamboo structures was very challenging and required constant supervision by the Mr. Azad. It was a completely custom job. The steel workers did not know how to work with bamboo, which proved to be very difficult for them. Welding the steel to the bamboo dwelling had to be carefully done to avoid burning the members. However, the steel workshop team was dedicated and completed the job by working day and night. After the installation was complete, the steel pipes were greased to ensure smooth movement of the interior pipe.

By the time the water bottle foundation was sealed and the bamboo floor was started it was already dark. However, the excitement of my team members and me was so great that we decided to work through the night in order to float the foundation to test if all our work would be successful. It was a cold night, but everyone worked very fast. The water



8.108. Grout lines cleaned by workers



8.109. Water barrier placed on top of water bottle foundation

8.110. (opposite) Water bottle foundation dwelling floating on water



pump was used to pump water from the pond into the foundation basin. As the water slowly rose, I was paralyzed with doubts. I feared my errors would lead to a building that did not float, or worse, the house might float but tip over and detach itself from the service spine. I sat alone on the second floor of the house going through the many possibilities as the water level rose inch by inch. Everyone else was eagerly waiting on the ground to see what they had only heard about. Nothing was happening, no sudden movements, no jolts, no floating. I climbed down the ladder to check. We had made a small mark on the brick wall earlier in the day to denote the original level. With a crowd behind me, I took a flashlight to see if we remained at the same level. It was if I could not believe it myself. I yelled out that we were off the ground. Everyone cheered in excitement. One of the bamboo workers put his leg into the water and checked if in fact the columns were off the ground, and they were. The house moved much more smoothly than I had expected. As the house rose a little more we noticed slow movements, but the vertical guidance system ensured that minimal tipping was felt. We allowed the house to float up to the maximum level of 3 ft. I sat back and watched, smiling to myself and thinking that the journey until that moment was worth all the troubles, and felt a jolt of energy that would last me the rest of the ride.



8.111. Water bottle foundation dwelling in buoyant state



8.112. Buoyant dwelling tested with live load



8.113. Bamboo frame with roof



8.114. Bamboo frame of second dwelling

DAY 56 - 60

January 6^t – 10th, 2010

The bamboo walls were first woven then installed onto the structure. The outer walls were easy to install, but the walls on the side of the service spine were very difficult and time consuming to install due to the lack of space. A carpenter was brought on site to install wood battens. Split Mulli bamboo was nailed on top of these battens to make the connection stronger and ensure the elevation was straight. These pieces were chemically treated with a mixture promoted by HBRI. Though more expensive than the boric acid and Borax mixture used before, this treatment was chosen for the portions that would be exposed to the environment.

I received a phone call in the morning informing me that Mr. Khan was going to visit the site in the afternoon to see its progress. I did not realize the importance of this event until there was chaos all around HBRI as staff prepared for his visit. We quickly tidied the site as much as possible and anticipated his arrival. To my surprise, he not only came with a large group of other interested members of the government, but also with two reporters from local TV channels. It was my first real audience, as we demonstrated the flotation of the dwelling with the water bottle foundation. Everyone was ecstatic to see the project in motion, and the LIFT house became national news that night.



8.115. Plumbing laid for drainage



8.116. Installation of interior bamboo wall



8.117. Jawa bamboo floor finish



8.118. Installment of walls



8.120. Installment of floor joists in ferrocement foundation



8.119. Mulli bamboo split for facade finish



8.121. Treatment of bamboo for facade finish



8.122. Bamboo used as a cup by worker





8.123. Mr. Khan's visit to the LIFT site



8.124. Reporters on site

8.125. (opposite) Installation of side wall finish



8.126. Installation of front wall finish

DAY 61 - 65

January 11th – 15th, 2010

The second bamboo dwelling was completed and ready to be tested. This was the one I was most nervous about because I had no idea if the foundation was leak proof or if the weight of the dwelling exceeded our hypothesis. We began pumping in the water, but there was no movement of the house for the longest time. The water kept rising and I could hear whispers behind me that the foundation was too heavy. I kept on running the numbers in my head to check if I had made a mistake along the way. It should have worked by now; the water level was too high.

Once again a volunteer put his leg in the water to check if he could get his toe underneath the foundation and to his surprise he put his whole foot in. He explained that the house was floating over 1ft off the ground. I ran inside and walked around to check for movement but I could not tell if the structure was floating; it was as if we were on ground. It was the greatest sense of relief for me. It was not that the house did not float; it floated too well.

Two employees of Grameen Shakti arrived on site to make the improved stoves. They brought with them two concrete chimneys and a few molds. Soil and bricks were used in forming the stoves on the first day. The employees



8.127. Dwelling on right floating on water pumped from the pond



8.128. Installation of Grameen Shakti improved stove



8.129. Finished bamboo railing on top slab of service spine



8.131. Construction of front steps



8.130. Front facade finish



8.132. Installation of Mulli bamboo strips as wall finish

returned in two days to finish and install the chimneys. We noticed large cracks forming and decided to plaster over the mud formed stoves.

The cisterns were filled with water to check for leakage. On the second day we saw noticeable water seepage through the brick joints. The failures appeared to be in the middle point of the service spine. After thorough examinations by the site engineer, structural engineer, and me, we discovered the problem was in the ferrocement joint inside. The water was pumped out and another layer of ferrocement was applied over the joint. In a few days we tested with water again and found that a little bit of seepage remained. The site engineer assured me that this would stop within a week as over time the tiny holes would become clogged by dirt. To be safe I had a representative from a waterproofing company take a look at the cistern and received an extremely high cost estimate to have him coat both cisterns. However, I decided to wait to see if Mr. Azad was correct, and it seems that he was.



8.133. Water seepage marks on the exterior of the cisterns



8.134. Interior stairs made of bamboo and wood



8.135. Installation of interior wall



8.136. Bamboo frame for kitchen on top of service spine



8.137. Installation of side walls

DAY 66 - 70

January 16th – 20th, 2010

These last days involved a considerable amount of detail work with the doors and windows as priorities. A team was assigned to weave the door and window finishes, while another team was busy installing the sliding window hardware. I chose to install sliding bamboo windows in order to draw a comparison to the modern applications of sliding glass windows which are extremely popular in high end homes. This was a challenge since all the hardware had to be custom designed to be applicable to bamboo. After a few life size models, we decided on a simple sliding system that allowed double bamboo shutter windows. In trying to design bamboo for a variety of uses, I came up with the idea of using bamboo for door handles and railings for the interior stairs as I worked on site with the material and learned of its possibilities.

The installation of the toilet roof that held the solar panels was challenging because of its close proximity to the amphibious dwellings. We feared that the dwelling might cause damage to the toilet roof when floating in high winds, and therefore required a gap between the two structures. This gap however, put the dwelling at a risk of receiving high amounts of rainwater. After considering many different design solutions, we installed a double panel of woven bamboo mats known as a “bhelki” under the roofs of the dwelling to keep the rain out.



8.138. Interior of bamboo dwelling



8.139. Shared exterior space on top of service spine



8.140. Railings being secured



8.142. Sliding window shutters being prepared by bamboo weavers



8.141. Raised Garden



8.143. Wood door frame covered with bamboo cladding





8.144. Interior “bhelki”



8.147. Steel plate attaching dwelling to vertical guidance system



8.145. Installation of toilet roof
8.146. (opposite) The LIFT house complete



8.148. Installation of sliding shutters

INAUGURATION

January 26th, 2010

A week before the inauguration, a young businessman, interested in the future of the LIFT design, came to meet and talk with me. I met with him in my father's Dhaka office. After a 5 minute summary, he was clearly interested in funding a few houses as a way of getting media attention. He asked me to meet him on site that evening where he brought a group of his advisors. Despite the compliments from the others, one of the advisors, who had attempted an amphibious design a few years ago, but never succeeded, was very negative. His attitude made it obvious to me that he was bitter to see the actualization of what he thought had been too difficult in the past. He criticized my material choice and regurgitated memorized facts to demonstrate his knowledge on the subject. After the men left, I realized one good thing had come out of this experience; it was now obvious that I needed a local office that could communicate with interested clients. My father arranged for a local office and I hired a receptionist to take incoming calls.

Mr. Khan showed incredible support for the project and the inauguration ceremony. With his help I invited the Minister of Finance and the Minister of Agriculture, two extremely influential people of the country to inaugurate the



8.149. Government officials at the inauguration



8.150. Speeches delivered at the inauguration

8.151. (opposite) Signage on front facade of the LIFT house

lift house
by prithula prosun

project. My parents too had worked incredibly hard, inviting and organizing the guests. The ceremony turned into a large event with attendance by many important people. It was crucial that I succeed in presenting the LIFT house because never again would I have so much focus on the project as I did on the day of the inauguration.

I arrived on site to find hundreds of people arriving to see the LIFT house. My construction team stood in front of the project proudly wearing the LIFT t-shirts. A large group of reporters and cameramen was busy setting up their equipment. Within a few minutes I was surrounded by newspaper journalists and found myself going through countless interviews until the guests of honour arrived.

The inauguration ceremony was a great success. I recognized the large number of people who were the reason this project became reality. All three guests of honour appreciated the project and made many positive remarks in the media. I demonstrated the amphibious nature of the dwellings which was very well received by the crowd. As the audience entered and walked through the floating homes, I gave interviews for TV channels, newspapers, and radio. On the night of the inauguration, as I flew back to Toronto, the LIFT house and I were on every national news on TV and in the newspapers.



8.152. Back facade of LIFT house from across the pond



8.153. Application of bamboo in many different finishes

8.154. (opposite) LIFT House after inauguration

8.155. (next page left) Construction sequence

8.156. (next page right) Photo of bamboo workers and key team members in front of LIFT House



lift house
by TWINKLESTUDIO



lift house
by: prithula prosun



PRESS CONFERENCE

April , 2010

Since the inauguration I received many phone calls and emails requesting more information on the LIFT house. There were a few interested clients who wanted to construct different versions of the LIFT design. Many were disappointed that I was no longer in Dhaka. At the end of March I flew into Dhaka to hold a press conference in order to explain the LIFT house once again. Many who missed the news coverage, but heard about the house from someone else, were still curious. I decided that the best way to address all those interested was through a press conference. I thought it would have been difficult to secure the presence of the media without big political names, but it was not that difficult since many journalists and reporters were already aware of the project and was interested in covering the story once again.

The press conference was held in April 7th in front of the LIFT house. It was smaller in size than the inauguration, and received less media coverage. However, the covered material was a lot more focused on the project and more in depth regarding the issues I sought to solve.



8.157. Press conference



8.158. Interviews with TV channels

POST OCCUPANCY

During the construction process a family of five showed considerable interest in moving into one of the dwellings. They were regular visitors to the site and volunteers for a lot of the work. After the inauguration, Lal Mia's family moved into the LIFT house with their belongings.

On my visit to Bangladesh in April 2010, I documented the family's living conditions. The house that I built from nothing was now someone's home. A warm welcome awaited me at the site with beaming smiles from the family. Lal Mia, a "forth class" employee of HBRI, had a very unpleasant accommodation before he moved into the LIFT house. Lal Mia's family includes his wife, son, daughter-in-law, and a daughter.

They seemed very happy in their unique home and explained that they received regular visitors who took tours of their home. When asked if they faced any problems, the family explained that water was entering through the gaps between the window shutters and the walls during rain storms. I immediately fixed the problem the next day by adding sun shades over the shutter to stop rainwater from dripping into the interior.



8.159. Water source



8.160. Bathing and dishwashing area



8.161. Residents use the ground floor as a multipurpose room



8.163. Residents studying inside dwelling



8.162. Second floor of dwelling occupied by residents



8.164. Lal Mia planting vegetables in garden



8.165. Solar light fixture



8.167. Furniture for storing belongings



8.166. Interior wall used to hang personal items



8.168. Ferrocement foundation dwelling on ground (left) and buoyant on water (right)



lift house

CHAPTER 9.0

CONCLUSION

When I began my thesis in January 2009, I did not imagine that I would be able to build my design. The LIFT house consumed the last year and a half of my life, from its conception, through design and construction, to occupancy; I was involved in every step. This was not an impersonal act of handing my drawings to a contractor who gave it form, but a totally consuming activity where I wore the hat of many professionals and fulfilled an array of duties on the construction site.

The LIFT house cannot solely be constructed with mechanical means, but requires a thorough human involvement which made the construction process very special to the entire team. Working with a combination of uncommon materials, the house required my continuous attention, making it an evolving process.

I faced many problems and uncertainty when I could not turn to an expert for answers. Confidence in the design proved to be my greatest tool. I resorted to finding answers by not asking, but doing. My limited experience in construction was the greatest challenge during the design phase. This led to making design decisions that later became too time-consuming to fulfill. Without adequate knowledge of how some materials came together, I made decisions based on aesthetics qualities rather than efficiency. Fortunately, a good percentage of this was rectified on site through consultation with Mr. Azad, and in some cases we had to find other ways to manage.

The construction cost of the pilot project with two units was 650,000 TK (approximately \$10,000 CAD), with the majority of the money spent on the service spine. The first prototype of a design always surpasses the cost of later implementation,

The dwelling is not situated in the objective world, but the objective world is situated by relation to my dwelling

Emmanuel Levinas, 1969

8.169. (opposite) The LIFT house with dwelling on the right floating on water

due to the experimental nature of the process. I strived to keep construction costs to a minimum even in the pilot project in order that the LIFT House could be marketed as an affordable option. My team worked very hard to keep costs down, but I still had to pay a premium price for the materials and labour due to the scale and schedule of the project. When the LIFT design is implemented at the scale of a large community, cost of construction will be much lower. Further improvements in the design will also ensure lower costs. Instead of building cisterns to supply enough water for the whole year, the size of the cisterns can be decreased by adding a deep tube well as a supplementary source of water. This will result in considerable savings.

Both the ferrocement foundation and the used water bottle foundation provide similar results when floating on water. The construction of the ferrocement foundation was significantly more expensive than the water bottle foundation since the used bottles were collected from a local hotel and not purchased. When implemented at a greater scale, it is possible for the ferrocement foundation to be produced as a prefabricated factory item that can cost significantly less, where it may be difficult to collect large amounts of used water bottles. The reuse of water bottles is a great solution in counteracting the environmental problems brought on by the discarded plastic bottles, and using it as a benefit instead.

Fire hazard is a concern in high density conditions with flammable materials such as bamboo. The LIFT House is designed with fire separators, the service spine, placed between the bamboo dwellings which inhibit the spread of fire. The LIFT community is designed so that even if an escalated fire is able to move to surrounding dwellings, the central courtyards create distances between clusters of dwellings to stop the spread of fire. The kitchens are also located outside the dwelling on the surface of the service spine to lessen fire hazards. The roofs of the latrines and kitchens can be constructed out of clay tiles and the walls out of bricks to act as fire separators.

A preliminary cost estimate indicates that future implementation of the LIFT House in sets of 8 to 12 units will cost approximately 250,000 TK (\$3850 CAD) for each unit. Field studies performed in slum settlements reveal that the average household income for the urban poor ranges from 3,000-7,000 TK per month. Figure 9.1 shows how different financing options can make the LIFT community affordable for the urban poor. Land can be acquired by three means:

1. Donation by the government of land already designated for low-income communities
2. Leasing unused government-owned “khas” land
3. Taking back and re-using illegally appropriated government-owned land

Figure 9.2 shows how the LIFT community can be constructed with a central courtyard shared by 12 units in each cluster. This layout can be used to implement the LIFT design at a larger scale where amphibious units can be used both as residential and commercial spaces. Figures 9.2-9.5 show speculations on how the LIFT community can be incorporated into the urban fabric. Retail spaces are indicated in the site plans with a red colour along key circulation spaces Figure 9.3 explores a scenario where the LIFT communities are inserted in an existing slum settlement, forcing open spaces that reduce crowding. Figures 9.4 and 9.5 speculates two different scales and layouts of the LIFT communities. The site plans incorporate ideas seen used in slum settings, such as shared spaces, narrow pedestrian paths linking residential clusters and the use of main circulation spaces as commercial areas with a large public square at the heart of the community. The projected population density of the LIFT community is approximately 125, 300 people/sq.km. The population density of Dhaka is 29,899 people/sq.km, where the typical slum is 220,166 people/sq.km, with extremely dense areas as high as 370,650 people/sq.km. Therefore, future implementation of the LIFT community would have population density higher than the city in order accommodate the population, and lower than current overcrowded slums.

Source of Finance	Construction Cost per unit	Rent Paid by Residents (monthly)	Repayment Period (years)
A LIFT community is fully financed as a humanitarian act by corporations, NGOs or as a project adopted by the Government	250,000 TK (\$3850 CAD)	0 TK (\$0 CAD)	0 years
The service spines of a LIFT community is subsidized by the Government and the bamboo dwellings are paid by the residents through a housing loan	Service Spine: 175,000 TK (\$2700 CAD) Dwelling: 75,000 TK (\$1150 CAD)	1250 TK (\$19 CAD) + interest	5 years
A bank provides the residents with a mortgage loan with a minimum interest rate	250,000 TK (\$3850 CAD)	1400 TK (\$22 CAD) + interest	15 years
An NGO or a corporation pays the cost of a LIFT community which is paid back by residents without interest	250,000 TK (\$3850 CAD)	2080 TK (\$32 CAD)	10 years

9.1. Affordability options for future implementation of the LIFT House



9.2. The LIFT community with 12 amphibious units



9.3. Speculation on future implementation of LIFT communities in an existing slum settlement

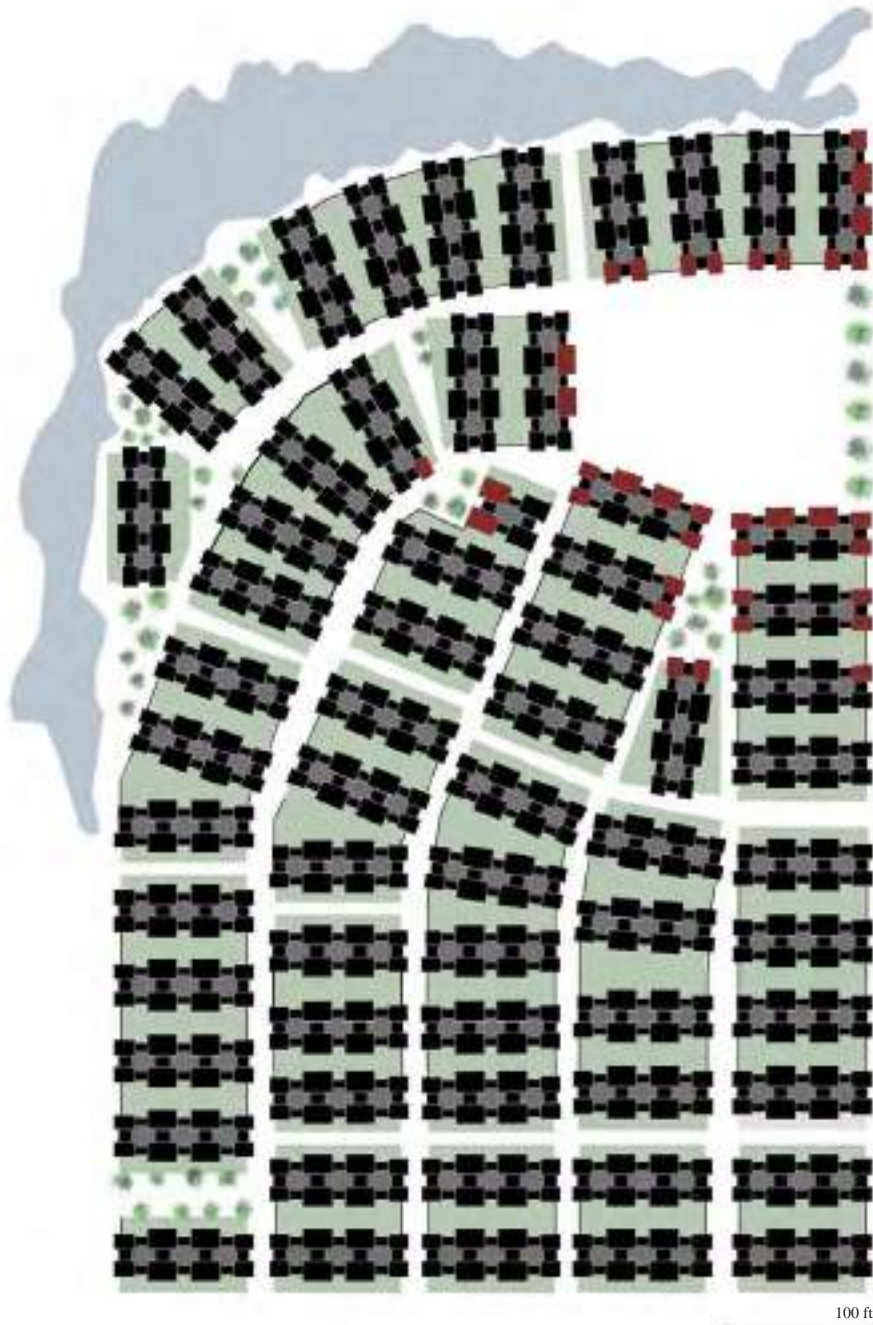

9.4. Speculation on future implementation of LIFT communities with 760 units

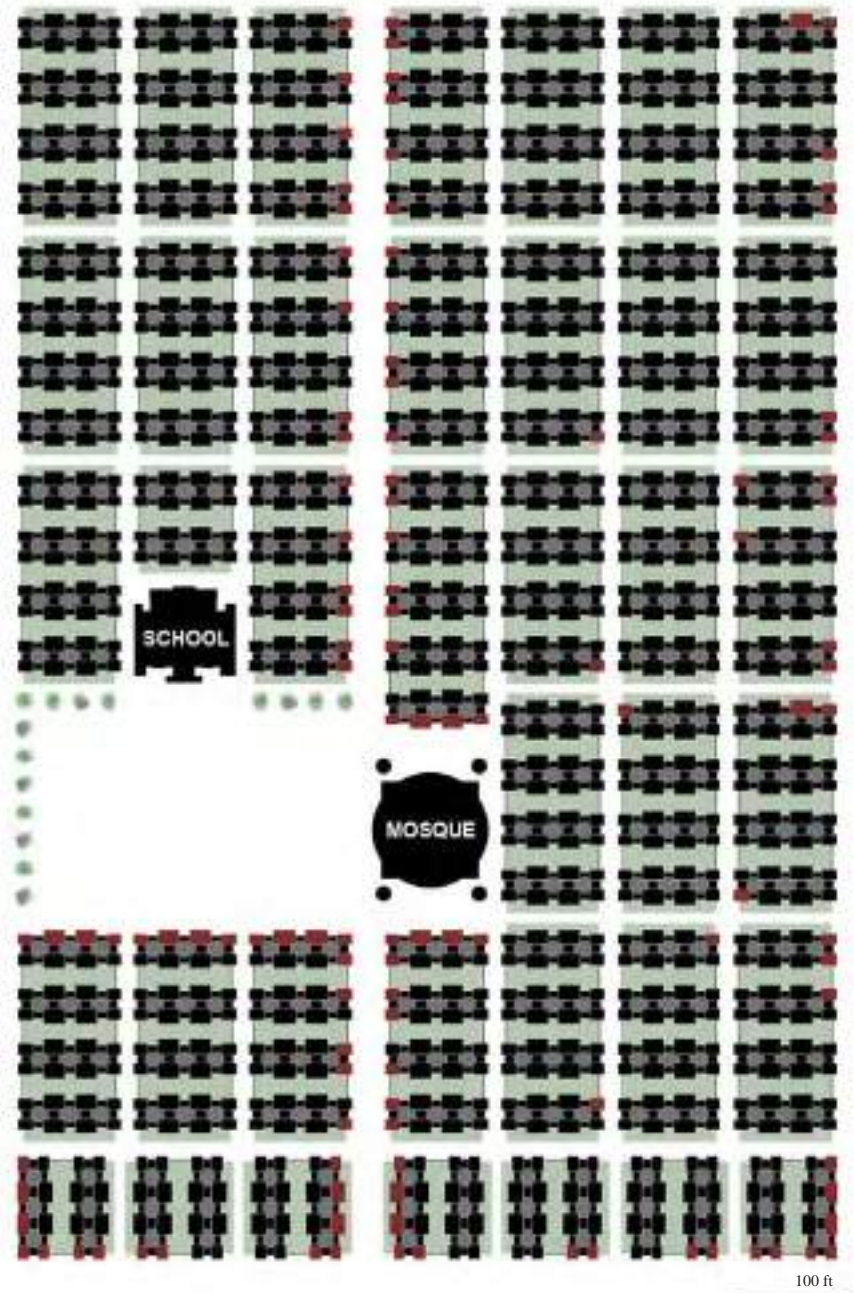

9.5. Speculation on future implementation of LIFT communities with 1644 units

I created the LIFT organization as a way of advancing the LIFT House to implementation and further development. Future implementation of the LIFT design will require cooperation from many different groups with a single goal of providing affordable flood-proof housing for the urban poor. The organization was formed in recognition of the great potential of the project and the challenges of gathering these groups of people together within an unstable political environment. A successful project requires coordination between the LIFT organization, the Government, social organizations or corporations, funding bodies and the residents themselves. Looking forward, the LIFT design will be further developed by the LIFT organization through funding in order to develop the most efficient and cost effective version of the design for future implementation.

A large number of proposal booklets were distributed to NGOs and organizations committed to helping the poor as an invitation to join hands with the LIFT organization for future projects. Before I left Bangladesh in April 2010, I met with the vice-president of a construction company who was interested in building 100 amphibious dwellings for the poor in a peri-urban area of Dhaka. Once I returned to Canada I designed a proposal for the company, indicating how much money the investment required and the possibility of a return of this money over a length of time, stressing the idea of a social business. Many large companies in Dhaka have the means and desire to help the poor, but do not want to donate large sums of money. A social business encourages a company to invest in a good cause but allows the company to retrieve the money through a repayment process.

The success of the LIFT House lies in its ability to focus attention on crucial matters such as flood mitigation, slums and the lack of low-income housing. At the beginning of this research, five parameters were identified for the LIFT House to fulfill.

- 1) Safety of life and protection of property in floods

- 2) Increase wellbeing of the inhabitants
- 3) Affordability for the urban poor of Bangladesh
- 4) Allow resident participation in the construction process
- 5) Promote income generation

The completion of these indicates the success of the project for the purposes of this research.

Safety: The LIFT House protects life and property during floods as demonstrated during many flood simulations after the completion of the project with occupants and their belongings in the house.

Wellbeing: The increase of wellbeing of the residents can be determined by using the UN Habitat's definition of wellbeing which includes five indicators:

- i) access to at least 20 litres of affordable water
- ii) access to improved latrine or toilet
- iii) secure land tenure
- iv) reduced overcrowding defined as less than 50,000 people per sq. km.
- v) adequate housing quality defined by protection from environmental hazards

Each resident of the LIFT House has access to over 20 litres of water without cost. The composting latrine system provides a safe and hygienic way of reusing human waste with minimal maintenance. The LIFT House provides a secure tenure for the residents. Even though the population density of a LIFT community is projected to be higher than the desired density by UN Habitat, the LIFT House addresses the lack of available land within the urban centres of the country and proposes a population density of approximately 125, 300 people/sq.km. that meets the current needs of the population. As discussed, the typical population density in slums of Dhaka is 220,166 people/sq.km, and reducing that to 50,000 people/sq. km. is impractical. The project protects residents by being resilient to environmental



hazards such as storms, earthquakes and floods.

Affordability: Residents are given an opportunity to own the house through monthly rents that are comparable to rents paid in illegal slum settlements.(Fig. 9.1)

Participation: The LIFT House is designed and constructed with low-tech materials and local skills in order to easily replicate the design in the local context. The project had many volunteers who gained knowledge and skills of constructing with bamboo. Residents are provided with an opportunity to participate in building their residence through a training program by local skilled workers in the bamboo portion of the construction, allowing them to use these skills in building the houses of their neighbours as an employment opportunity.

Income Generation: By providing residents with a two storey flexible space, residents have the opportunity to participate in home-based businesses. The upper level is a more private area with connections to the kitchen and toilet area, which allows residents to use the lower level as an area open to public and connected to various economic activities. The ferrocement foundation also allows a unique opportunity to use the empty space underneath the floor as a large storage area.

The LIFT House responds to the crisis of floods, environmental degradation, and the housing needs of the urban poor. These major issues are all currently being tackled by the country, which is why the LIFT house became part of the national dialogue. After its completion, the project received considerable recognition through the media. I was invited to the Institute of Architects in Bangladesh (IAB) as a guest speaker. In February 2010, Dr. Elizabeth English invited me to present my work at the Building Resilience Workshop in New Orleans. The research conducted for this project also led me to receiving the Architectural Research Centers Consortium (ARCC) King Student Medal for excellence in architectural and environmental design research. The project will also be a part of the upcoming publication *Design Like You Give A Damn 2* by Architecture for Humanity in 2011.

Despite positive feedback and many inquiries, organizations have not yet taken any steps towards future implementation of the LIFT



design. Apart from being a design that caters to the low income population of the country, the novelty of the LIFT design has the potential of attracting tourism. The unique design involving local crafts can become an addition to the resort industries which are becoming more and more popular in the country. The LIFT house has the ability to provide an individual with a rural experience with modern comforts.

The LIFT House represents Bangladesh: an embodiment of what is important to the country, its people, its environment, its economy, and its water. The house can become a symbol of the country's reaction to climate change, where the rise in sea levels is not seen as a threat, but a circumstance to which one adapts. The house reconciles this land with its water. Floods are a fact of life and the LIFT House allows this natural process to co-exist with urban life. In the future where wars will be triggered by the scarcity of freshwater, Bangladesh will soon need to resolve its relationship with water. Rather than interventions that restrict, the country will have to accept the passage of water and embrace it as a commodity.

The LIFT House is a balance between the old and the new, indigenous materials with modern technology. The house, neither rural nor urban, is designed for a country in transition, where rice paddies are quickly disappearing and being replaced by pseudo urban conditions. It is difficult to imagine the house in another country because the design is so integral to the lifestyle of the urban poor of Bangladesh. This design speaks to the unique conditions of the country and when developed in a larger scale, will become an icon for Bangladesh.

The LIFT House is not merely a place of shelter, but a space to nurture one's dream, grow a family and embrace nature. It creates a new vision for the country, one in which man and nature, land and water, poverty and dignity, resistance and acceptance, all discover a new equilibrium. For the poverty stricken man, fear is replaced with a new sense of hope.

The floods of despair will simply pass by,
and the human spirit will rise.

APPENDIX: A.1 IDRC COMPETITION PROPOSAL

ABSTRACT:

Rapid urbanization in Dhaka, Bangladesh has forced a large portion of the city's population to take shelter in substandard housing in slum and squatter settlements deprived of basic services. The heavy influx of rural-urban migration, amongst other factors, has resulted in a housing market that does not cater to the urban poor. Large public housing initiatives have proven to be inadequate to solve the problem of housing Dhaka's slum and squatter inhabitants.

Frequent floods in the city have further deteriorated the lives of the urban poor, creating great economic losses and an array of health problems. Low lying portions of the city experience annual inundation due to the overflow of surrounding rivers and heavy monsoon precipitation, creating a threshold for development. The high land prices of Dhaka make these flood-prone areas especially attractive to hazardous slum and squatter settlements.

The design proposal provides a solution for housing that will become a new typology for urban slums and squatters. A prototype of a sustainable amphibious housing community will provide opportunities for home based income generation aimed at empowering women. The design consists of a service spine which is a concrete structure that contains all the service connections and houses green technologies such as composting toilets and rainwater harvesting cisterns. The structure for the amphibious houses attach to the service spine that act as the vertical guide. The chosen residents, currently squatter inhabitants, will be responsible for taking a micro-credit loan to finance and construct the finishes and roofing for the amphibious houses. This innovative prototype of flood protected housing for the urban poor will begin a process that can spread and adapt to the slum and squatter areas of Dhaka, giving each citizen a chance to exercise their right to decent housing.

INTRODUCTION:



Purpose:

The proposal for the design award will provide sustainable housing for the urban poor of Dhaka city to create permanent live/work amphibious structures protected from floods.

Problem and Justification:

Dhaka, the capital of Bangladesh, is the fastest growing mega city in the world with 28% of the population under the poverty line. (World Bank, 2007) Due to rural-urban migration amongst other factors, the city of Dhaka has experienced rapid growth since 1972, after its transformation from a provincial capital to the national capital of the newly independent country, Bangladesh. An estimated 300,000 to 400,000 new migrants, mostly poor, arrive to the city annually. Dhaka's average annual growth rate was 6% between 1974 and 2001. In 2007, the population for the city of Dhaka was 6.7 million and the larger mega city over 12 million (BBS, 2008) It is projected that by 2015, the Dhaka mega city will be the ninth largest urban centre in the world. (World Watch Inst., 2007)



Population Explosion of Dhaka Megacity

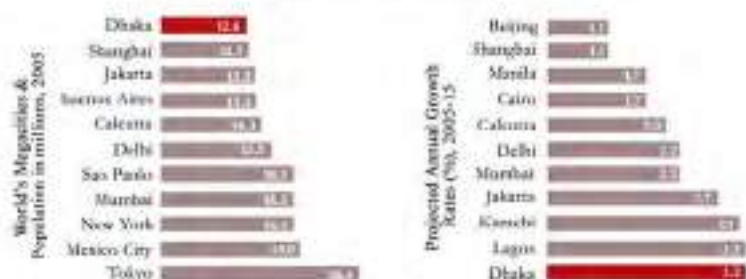

Source: UN World Urbanization Prospects: The 2003 Revision

As the city's population continues to grow, access to adequate housing is denied to the low income citizens forcing them to find shelter in slum and squatter settlements. According to a preliminary survey report by the Centre for Urban Studies in 2005, there were approximately 2,840,000 people living in slum and squatter settlements distributed over 4,360 concentrations in Dhaka city without basic human needs and services. (Eaton and Hossain, 2007) The increase in corruption, housing demands and land values have led to a housing market that does not accommodate the needs of the urban poor of Dhaka. The poor are forced to pay high rent to live in substandard conditions of the slums and squatters, leading to the degradation of

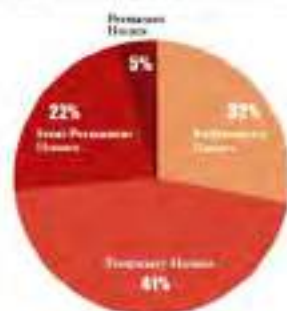

Source: Islam, 1996

the physical and social environments of the city. Islam (1985) found that slum settlers of Dhaka were paying higher rent per square meter than non-slum households, even though the latter was legal and received far better services. Based on a study conducted in 1995, only 5% of the poor of Dhaka lived in permanent houses, 22%

lived in semi-permanent houses, 41% in temporary houses and the remaining 32% in rudimentary units. (Islam et. al, 1997) The average per capita floor space in urban households averaged 5.1m² in 1991, compared to a densely populated slum floor area per capita as small as 1.2 to 1.5 m². (Islam, 1996) With the increase of land values, slum and squatter settlements continue to become denser.

Housing Tenure of the Urban Poor - 1995

	Dhaka			All Urban		
	Hardcore Poor (%)	Moderately Poor (%)	All Poor (%)	Hardcore Poor (%)	Moderately Poor (%)	All Poor (%)
Owner	16.4	16.2	16.3	28.8	25.5	27.7
Tenant in private house	42.4	49.6	45.4	45.6	48.4	46.6
Government tenant	5.6	5.2	5.4	5.0	7.6	5.9
Sub tenant	5.2	5.7	5.4	3.0	5.5	3.2
Rent-free	9.3	5.7	7.8	7.6	5.2	6.8
Illegal	20.2	16.1	18.5	9.5	8.8	9.3
Others	0.9	1.5	1.1	0.5	1.1	0.7
Total	100	100	100	100	100	100

Source: Islam, et. al, 1997

Dhaka has a history of violent slum and squatter evictions and continues to carry on evictions with the lack of resettlement plans. This instability in the lives of the slum and squatter inhabitant hamper their abilities of long term life and economic plans. According to the study conducted by the Government of Bangladesh in 1995, it is estimated that 97% of the urban poor of Dhaka do not own land. The land prices of Dhaka are comparable to the suburbs of New York, even when the average income of the residents of Dhaka is a hundred times lower. The primary cause of such high land prices is the scarcity of land resulting from the geographical location of the city in a delta region.

Costs of Developed Land

Location	US\$* per sq.m
High income areas such as Gulshan, Banani	430 to 650
Middle income areas such as Dhanmondi	330 to 430
Other Dhaka neighborhoods	210 to 330
Mirpur and other suburban areas	150 to 210
Undeveloped land at 20 to 30 km from CBD	3.7

* US\$ 1 = approximately 69 Taka (2009)

Source: Kamruzzaman 2007

Dhaka is situated in a floodplain surrounded by rivers that periodically flood the lowlands around the city. The high density of Dhaka (14,608 persons/km², up to 200,000 in some areas of the city) is a result of the scarcity of land with high elevations. This topographical condition has led to the development of the city in a north-south pattern, rather than in a circular one. Most of the high lands that are protected from annual flooding are already developed. The remaining underdeveloped low lying lands become attractive to slum and squatter settlements. Floods remain life threatening for these low lying lands and a destructive force that impedes in the daily lives of the urban poor.

Bangladesh occupies the deltaic floodplains of two of the world's biggest rivers, and is responsible for draining large volumes of water from surrounding countries, including the Himalayas. (Brammer, 2004) Severe floods in Dhaka are mainly caused by overflow of surrounding rivers, as well as internal water logging. (Huq and Alam, 2003) In recent history, the city experienced major floods due to overflow of surrounding rivers in the following years: 1954, 1955, 1970, 1980, 1987, 1988, 1998 and 2004. Among these, the 1988 flood had inundated 85% of the city with depths ranging from 0.3-4.5 meters affecting 60% of the city

SLUM LOCATIONS & FLOODING



Source: Centre for Urban Studies, 2006

dwellers. Heavy monsoon rainfall is another cause for floods and becomes a severe problem for certain areas of the city that are inundated for several days. The water depths in some areas reach 40-60 centimeters, creating infrastructural problems, economic losses and disruptions to communication networks. Along with rising water levels, floods bring on a scarcity of clean drinking water and a variety of health problems and diseases for the slum and squatter inhabitants. More than ever, concerns for global warming

have brought the issues of flood mitigation to the forefront for low lying areas around the world. A one-meter rise in sea level in Bangladesh will result in a loss of 17.5% of land area,



Source: Statistical Yearbook of Bangladesh 2007

effecting 13 million people. (World Watch Inst, 2007) At the current state, the city is unable to adapt to the rising water levels from annual flooding, and the added stress of rising sea level due to climate change will be catastrophic.

The annual housing need for Dhaka is 250,000 dwelling units per year, two thirds of which are required for the urban poor. (Rahman, 2007) Much of the initiatives taken by government and social organizations have resulted in "dead aid" where the money allocated for the cause did not reach the disadvantaged. Units built through public programs are most often bought by the lower middle-income households due to the high prices and lack of any systems employed to make these units more affordable. Numerous organizations like CARE and the World Bank have initiated large scale aid to urban slums of Bangladesh, but none included a housing component, and resulted in very little impact on the improvements of slums in Dhaka. NGOs like Grameen and Proshika among others are doing successful work in training and income generating activities in the slums and squatters of Dhaka. However, no real initiatives are taken to improve the housing conditions that can be a great tool in reaching the goals of these organizations.

Micro-credit programs have proved to be an effective tool in the fight against poverty. Through Dr. Mohammed Yunus' Grameen Bank initiative, the urban poor have access to micro loans that can be used for small business initiatives. However credit alone cannot liberate the urban poor from the slums and squatters of Dhaka. An opportunity for home based income generation can empower women and use the home as a hub for the family's economic activities. Current conditions of slum and squatter dwellings do not allow flexibility for these activities to take place.

The income of women is crucial for the survival of low-income families in Third World cities. In the male dominated culture of Bangladesh, women are not given equal opportunities. The value of women in the workforce is grossly undermined in the city of Dhaka. Women from low-income settlements have the potential to self-create jobs and have

shown significant results in creating home based income. (Mahmud, 2003) Many NGOs are currently working to train poor women for skill development. Income generating training programs aim to generate skill and make poor women capable and empowered to be self-employed. However the problem remains that most of these trained women do not continue to apply their knowledge in home based income due to impermanent tenure and the lack of space for such activities. Most beneficiaries live in rented houses with a total space of 14-19 m² with limited access to exterior space. A 1.5-2 m² table is therefore difficult to fit in their current space that can be used for sewing, embroidery, block printing and making ornaments, some of the most in demand self-created businesses for women. (Sharmeen & Parvin, AED 2007)

Reasons For Not Employing Trained Knowledge

Reasons for not applying trained knowledge	Percentage
Lack of space at home for activities	32 %
Problems with child care and household works	15 %
Lack of knowledge about source of raw materials and place of marketing	31 %

Source: Sharmeen, 2004

In the socioeconomic context of the city as women are assigned the sole responsibilities of home management and child care, many women fail to participate in income generating activities due to the absence of having alternative persons for child care and household works. The credit received for utilizing their trained knowledge from NGOs is often surrendered to their husbands who apply the credit in other activities. (Sharmeen & Parvin, AED 2007) In this way, the goal of empowering poor women through training and credit is not achieved. After a period of time the women lose the knowledge they gained through the programs, making all the resources invested in their training useless. Along with the lack of space, the tenure security is another factor that becomes an obstacle for home based income. According to scholars

(Rahman, 1999; Mahmud, 2001) tenure security will encourage more low-income women to transform their domestic spaces for economic activities than their male counterparts.

Scope:

RESEARCH:

The design project will encompass a body of research to understand the lifestyle, needs and potential of the slum and squatter settlers of Dhaka. The aim of the research component will be to map a section of the *Sattala Baste* located in a flood prone area of the city to understand the social, economic and political forces present. The research component will also include an investigation into rain water harvesting technologies, composting toilets, photovoltaic technologies, low cost construction materials and methods of Dhaka and the engineering of amphibious structures. In addition, the research will also include a study of the micro-credit system intended for poor women in order to be used as a housing loan.

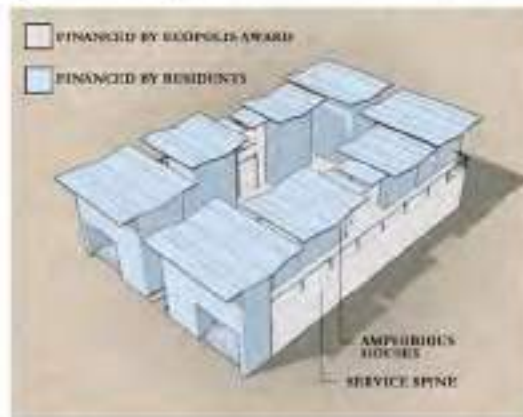

DESIGN:

The design will provide a solution for housing that will become a new typology for urban slums. A prototype will be constructed consisting of a service spine, a structure which will contain all service lines and green technologies,

to which structural components of eight amphibious houses will be attached. By separating the services, the amphibious houses can be constructed lightly to achieve easy buoyancy. A

communal vegetable garden will be located in the centre of the courtyard shared by all eight households. The exterior cladding, roofing and interior finishes will be installed and financed by the residents themselves with local vernacular materials. This will be achieved through micro-credit loans and supervision from skilled workers employed by the project. The prototype will be constructed in an existing government owned squatter area of *Sattala Baste*, where government workers and their families were granted temporary land rights. The existing settlers will be temporarily relocated for the duration of the construction. The prototype, consisting of eight two-storey amphibious houses and two infrastructural spines, will be the beginning to a healthier neighborhood that fosters communal bonds and allows home-based income. Each house will have a lower unit that will be the live and work space with kitchen, and an upper unit with the sleeping space. Construction will be completed in April 2010.

Definitions:

It is important to understand the definitions of a *slum* (*Baste* in Bengali) and a *squatter settlement* (*Bastuhara colony* in Bengali) in Dhaka. *Slums* are defined as substandard housing built on privately owned land, where *squatter settlements* are substandard housing built illegally on publicly owned land. The share of *slums* have significantly increased over time due to the rapid increase of the city limits, and evictions from government land limit the growth of *squatter settlements*. *Slums* are residential areas of very high population density, high room density (three or more adults in one room), and poor housing with inadequate access to basic civic amenities. *Slum* areas are home to approximately 40% of Dhaka's population. (Ullah, 2004)

Amphibious houses are structures with buoyant foundations that are constructed on solid ground with capabilities of floating up with rising water levels. The Netherlands has

been the pioneer in employing this technology to the low lying flood prone areas of the country. *Amphibious houses* address the concerns for floods and heavy rain, and are capable of addressing the added concerns of rising water levels from global warming.

The Grameen *micro-credit* system has proven to be a successful tool for economic independence among the poor in Bangladesh. Small loans are given to individuals without collateral or signing any legal instrument, and charged a small interest rate. A borrower must belong to a group of five people who work together and help each other pay off the loans. However repayment responsibility of a loan rests solely on the individual borrower. Since its establishment, the program has lent credit to 7.8 million people, 97% of them are women. The Grameen *micro-credit* loan program has proven to be a system that empowers poor women across the country.

Research Questions and Initial Hypothesis:

Question: Can amphibious houses be a replacement for substandard housing of the slum and squatter areas of Dhaka?

Hypothesis: The amphibious houses will allow residents to keep their belongings and family dry from the flood without damage. They will be able to continue much of their daily and income generating activities

Question: Can sustainable technologies, such as rainwater harvesting, composting toilets and photovoltaics, be a cost effective solution for providing services in slums and squatter areas of the city?

Hypothesis: The initial cost of such technologies would be higher than the standard method, however the long term performance of these technologies would make them cost effective environment friendly options.

Question: Will the overall quality of life and mental wellbeing of residents be enhanced by the design project?

Hypothesis: A measurable difference would be found in the enhancements achieved by the project. The start of home based economic activities, physical and mental health, increase in income, higher enrolment in education institutions and planning for the future will be some of the differences noticed amongst the residents.

OBJECTIVES:

The design project will produce a written report on the extensive research to be conducted on affordable green technologies, inexpensive construction and low cost buoyant foundations, and the successes and failures of the integrated service spine. After construction of the eight houses, at least 50% of the households should be participating in a home-based activity to generate income, in which women take leading roles. The communal vegetable garden should sustain vegetable intake for all eight households for at least half of the year. In the event of a flood, the houses should independently rise with water levels and inhabitants should have access to water, electricity and toilets. There should be a 100% repayment rate of the micro-credit housing loans, taken to construct the cladding and interior finishes, in small monthly installments. An overall increase in quality of life, health and wellness of inhabitants should be achieved overtime, which can be recorded through questionnaires and interviews.

THEORETICAL APPROACH:

Schumacher (1993) describes that "Development does not start with goods; it starts with people and their education, organization, and discipline."(pg 138) The organization,

Schumacher explains, must have “a certain appropriate scale, and the more active and intimate the activity, the smaller the number of people that can take part, the greater is the number of such relationship arrangements that need to be established.” (pg 50) To begin to comprehend the overwhelming problem of providing affordable housing for the 3.4 million urban poor of Dhaka, one must first understand the individual and his needs. The bottom-up approach that this design project will implement can only be attained when the design is performed in the scale of a community to encourage the pre-existing relationships to flourish. “There is wisdom in smallness” (Schumacher, 1993 pg 22) Humans organised in a small unit will take better care of their share of the land and natural resources than anonymous companies or large government organizations. Therefore an important idea of the design project is that residents must own the dwelling portion of the project and use their natural abilities of self-reliance to complete their houses. The majority of the slum and squatter inhabitants of Dhaka are rural migrants who bring with them a strong sense of self-reliance to the city where they must rely on their individual capabilities for survival.

Micro-credit institutions recognize the human right to credit and make it possible for the extreme poor to participate in the program. Similarly, the design project applies the principle of micro-credit to architecture where the service spine of the design is lent to the inhabitants as a tool for healthier living conditions. Over a period of time the inhabitants will change their current economic state and move to a different dwelling and leave the service spine for the next household to be attached onto. Ownership of the portions of the amphibious house constructed by the inhabitant is given to the micro-credit recipient, which in most cases are the women of the households.

It is important to encourage participation of the inhabitants in the process of construction and allow them to construct and own their houses. Large scale interventions of the past have shown that donating large sums of money or resources is not a solution, rather the urban poor must be given the tools to succeed. It is through ownership and the opportunity to participate in constructing one’s home that the urban poor of Dhaka will form greater connections with the physical environment. The Egyptian architect Hassan Fathy has found through building the town of New Gourná that the complex issues of providing shelter for the poor go beyond beautiful architecture or the services provided. One must first understand the culture and lifestyle of the urban poor. When projects become fixated on the problem at the large scale it rarely solves the issues at the human level. This design project will aim for flexibility of structures and spaces to allow the inhabitants to adapt their lifestyle to the amphibious houses.

Rapid urbanization has caused architecture to move away from vernacular design towards use of modern materials that do not suit the climate and culture. Corrugated tin as a building material has become a symbol of status, yet poses numerous problems of rusting and thermal comfort. The design prototype will empower indigenous materials and vernacular architecture to resolve issues of ventilation, passive shading, ease of applicability and cost.

The amphibious houses built in the Netherlands and the works of Dr. Elizabeth English in New Orleans, U.S. have greatly influenced the design. Both bodies of work tackle the challenges of flood mitigation while preserving existing culture driven architecture. The design project will apply the principles of the amphibious houses being studied in the Netherlands and the U.S., but modify it to conform to Dhaka’s needs for an inexpensive solution. Unlike the foam lined reinforced concrete foundations of the Netherlands, and the

use of Styrofoam to achieve buoyancy in the U.S., Dhaka's amphibious houses will test empty drums and air filled plastic bags as an alternative solution along with two houses with hollow concrete boxes. The two international precedents are located in areas that face less frequent floods than in Dhaka. With Dr. English's guidance, the design project will address the unique conditions of the frequency of floods, climate and people of the city, and contribute to the advancement of the principle of amphibious houses that will prove to be a useful system for flood mitigation around the world.

METHODOLOGY:

RESEARCH

Data will be collected using a questionnaire survey administered during August-September 2009 in the *Sattala Bastee* area in Dhaka. Both close and open ended questions would be used with a standard technique to ensure proper representation. A sample of 100 households would be represented. Two extra experienced interviewers would be recruited for data collection and will be trained for consistency during field work. To overcome any inhibitions from the squatter settlers towards communicating with interviewers, sessions will begin in a group conversation without video recording over a few weeks to gain trust from interviewees. Once preliminary inhibitions are removed, interviews will take place in a private setting with only the family, such as the dwelling of the individual, with video recordings of the sessions. Most questions are expected to be answered with honesty except questions regarding earnings and occupations. Women of squatter settlements can be involved in prostitution and men in the narcotics business. These facts will be denied or hidden during the interview process due to social embarrassment or fear of arrest. Earnings of households are

often concealed information from neighbors to avoid an increase in rent or theft and will likely be fabricated in the interview process. These obstacles in retrieving information can be minimized by communicating with added sensitivity to the interviewees and gaining their trust. However, some limitations will remain and must be taken into account based on findings from other scholars. The chosen location of *Sattala Bastee* will be mapped extensively through photography, video recordings and orthographic drawings to reveal the physical and social boundaries of the site.

The specific location of the design project prototype will be chosen based on the mapping exercise to find a site close to main roads that consists of the chosen demographic. Another set of interviews along with detailed documentation of the dwellings of the chosen eight families will follow. Families will be chosen within a close proximity to each other to represent a variety of income, occupation, and family status.

All data collected towards the desired technologies and construction methods will be from secondary sources. A two week trip across Bangladesh will be conducted to document vernacular materials and its applications to residential architecture. Photography will be the primary medium of documentation as well as conducting interviews with local craftsmen and construction workers. An emphasis will be put towards visiting rural areas of Bangladesh since much of the urban fabric has been taken over by modern building materials with very little traces of vernacular architecture. A one week trip to Delhi and surrounding rural areas would be conducted to research precedents of sustainable low cost housing.

Once sufficient data is collected regarding sustainable technologies, a sample will be bought from each chosen local and foreign manufacturer. A temporary fieldwork area will be allocated in February, 2010 to test samples. The efficiencies of the different systems will be

recorded along with the energy requirements for functioning. Once test results are documented and analyzed, manufacturers will be chosen based on cost, function, maintenance, dimensions and ability for local productions. The most cost effective productions, such as the composting toilet seats, water cistern and filtration parts and photovoltaic batteries will be given to local slum area producers to replicate. If quality and performance of the products are not jeopardized, the chosen products will be manufactured by local workers, with preference given to women. This approach allows squatter production businesses to flourish and can achieve a direct connection to the housing project.

CONSTRUCTION

Phase-1 construction will commence by temporarily evacuating residents from the project location. A few residents will be employed for field work help during construction along with a construction crew. Chosen residents will go through two days of on-site training before commencing the work. Training will take place on construction grounds at a safe distance away from excavations. The groundwork will be minimal as excavation is only required for the service spine. The recovered soil from the excavated areas will be used to raise the shared courtyard space, a technique similar to the one traditionally used in rural Bangladesh of digging a pond and using the soil to build up the homestead. The two service spines will have a reinforced poured-in-place concrete shell. The walls of the service spines will be built up as different systems and services, such as the human waste composting compartments, are inserted. The vertical guide for the amphibious part will be placed in the formwork before the concrete mixture is poured. All walls above ground will be painted white for maximum solar reflection. Once the service spine is completed a concrete slab attached to

the spine by steel connectors will be poured. Four columns and roof beams will be constructed out of reinforced concrete.

Phase-2 of the construction is the completion of the amphibious houses. The concrete works will be complete and moved out of site at this point. Three types of buoyant foundations will be experimented with where 3 houses will have empty drums attached to the underside of the concrete slab, 3 houses will have inflatable plastic bags attached and the remaining 2 houses will be constructed with hollow reinforced concrete compartments. Each household will be put in connection with a local Grameen micro-credit bank for a housing loan. The small loan granted by the bank will be enough for indigenous materials and assembly by the residents. Eight skilled workers will be employed to supervise the assembly of the exterior cladding, roofing and interior finishes for the houses. Local low cost materials, such as bamboo, thatching materials and micro concrete roofing (MCR) tiles will be made available for purchase to the residents. If demand is high, the MCR tile producing equipment will be purchased for the project for manufacturing on site. For approximately \$5000, the necessary equipment and training can be attained for onsite manufacturing and assembly of the tiles. At project completion the machine will be sold to one of the residents at a minimal cost to start a small business. MCR is a cost effective roofing material that has found successful market in Latin America, East and West Africa and India and yields up to 40% of the investment within the first year of production. With the completion of the design project prototype, MCR tiles will be introduced to the Dhaka market and demand will likely follow given its success in other third world countries with similar climates.

A varying aesthetics for the exterior cladding is encouraged to represent the unique personalities of the eight households involved. However, to avoid substandard materials and

construction methods, a series of suggested design choices will be presented to the residents to choose from based on the research conducted in vernacular architecture from across the country. Since the actual construction of these houses will interrupt the current employment of the residents in order to finish the project within the set deadline, the residents will be paid to complete Phase-2 construction. This is a unique situation for the construction of the prototype due to time restrictions, and will not be necessary in future projects. At the end of construction, a detailed budget for the prototype will be created for future use, taking into account all that was found in field work. An added cost would be associated with constructing a new typology for housing in Dhaka, much of which will be negligible once the design is replicated.

At the completion of Phase-2 construction, the housing units will be ready for occupancy. In order to measure the success of the project, a series of data will be collected for analysis after 3 months into occupancy. Two experienced data collectors will be employed to conduct interviews with each household and the individuals within the family. Detailed documentation will be done about changes in food intake, daily activities and economic status amongst other factors. The interviewers will also be trained to answer any technical questions regarding the living conditions of the prototype. Data will also be collected from the service meters around the housing complex to record intake of water, electricity and other services. At the event of a flood, documentation will be done to see the performance of the 3 different buoyant foundations. If a flood does not occur by July 2010, this particular documentation will be pending until a rise in water level takes place. The collection of all these data will make the project's success in changing the residents' living conditions measurable.

FEASIBILITY:

The research component should not encounter difficulties in retrieving data due to the established affiliations to academic and government institutions. Securing developable land in a pre-existing slum or squatter settlement could face difficulty. However, cooperation is anticipated due to the chosen site of *Sattala Baste* being government owned and the nature of the prototype's small intervention. The government of Bangladesh's Housing Authority is currently doing extensive research on low-income housing for the urban poor and this project can be used as an experiment for the department.

Due to the nature of construction, 6-8 households with illegal holdings of the site, excluding the future residents, will be temporarily relocated. Out of which approximately 6 households will be permanently re-located with compensation and a resettlement plan that is out of the scope for the design award budget. The National Housing Authority of Bangladesh will be consulted for aid in the resettlement plan. To avoid unfair evictions, the project will hold a community meeting where the options of re-location will be presented with compensation. If cooperation is not received from the government and current squatter inhabitants, private land will be secured through a secondary funding source to construct the prototype, as per the project schedule. Construction will be carried out with extreme care so that no other households are disturbed. The nature of the construction is very low impact and requires very minimal modifications to the physical environment. The prototype is designed to be integrated into the existing physical and social fabric of the site.

As an advisor to the design proposal, Dr. Elizabeth English will oversee the engineering of the buoyant foundations. The construction drawings will be further approved by local engineers to ensure the quality and safety of the structures.

Some interruption from local mafias and opposing political parties could pose temporary problems, which could extend the timeline of the project. Data collected after the construction of the project may be insufficient to implement the project in other sites. The prototype will need to perform through at least one full year to demonstrate the viability of the solution as a whole. The extended post-occupancy report is out of the scope for the ECOPOLIS design award and will be conducted by monitoring the prototype through one year after occupancy.

EXPECTED RESULTS AND IMPACTS:

The United Nations Human Settlement Program, in a 2003 report titled ‘The Challenge of the Slums’ declared, ‘The urban poor are trapped in an informal and ‘illegal’ world – in slums that are not reflected on maps, where waste is not collected, where taxes are not paid, and where public services are not provided. Officially, they do not exist.

In a city where 40% of the population resides in slums and squatter settlements, the design project proposes to make these invisible people visible; to break the social and physical boundaries thrust upon them and grant them their right to decent housing. Housing, as a service for the economically disadvantaged, is critical for their self-image. Architecture is a crucial addition to the list of social and economic variables that enhances the welfare of the individual. This design project recognizes the importance of having a permanent house within the city and becomes a way to empower the urban poor of Dhaka and help them place permanent roots in the city.

The residents will be given a healthy environment that is flexible to their varied needs, and able to grow with them as they advance economically. For instance, as a household sees

an increase in income due to the added opportunity for home based businesses, the family may choose to upgrade their bamboo screen cladding by integrating more expensive materials, or choose to put an addition to the house. As the residents are ready to move out of the area, all materials owned by them can be sold or unassembled and taken with them. Services such as clean water, toilets and electricity for personal items from sustainable sources will allow minimal dependency on city services, which have proven to be unreliable. These services will liberate the residents from the daily load shedding and scarcity of water during floods, problems even the high income groups of the city face. Low cost composting toilets will allow residents to use composted excretions as manure and soil conditioners for the communal vegetable garden. The garden will be a social condenser for the households and a constant supply of food. It is also a method of cooling the local climate and absorbing greenhouse gases. Along with the environmental benefits, cultivation of the land is an important tie to the origin of most slum and squatter settlers who migrated from rural Bangladesh where farming is the most common livelihood. Connecting the residents to the memories of their past is a way of reconciling their future.

Home is within the domain of the women in Dhaka, and therefore bringing economic activities to the home is crucial for the well being of the family and the empowerment of women. The women can generate income within the house while simultaneously taking care of the children and doing necessary housework. The network of training resources for women already established in *Sattala Bastee* area can be implemented for the desired outcome when the residents can own a permanent dwelling with flexible spaces. Through the micro-credit program, women are more likely to receive loans than men, which put the women in the position to be the owners of the houses. Women are often seen as expendable resources, many

living quietly in fear because if abandoned by their husband, they do not have the resources to survive. Owning a house in the city significantly changes their position in society, within the family and most importantly, gives them a sense of pride and accomplishment that becomes a force of empowerment.

The beneficiaries of this project will go beyond the eight families who will reside in the amphibious houses. The government housing department and academic institutions can benefit greatly from this project. The prototype will be a new typology that government initiated projects can install in unused government owned squatter lands. A long term lease can be given to the residents in order for the government to use the land when needed in the future. The service spine of the project is a component that will be required to be installed through government initiatives or NGOs. Many foreign organizations and institutions, such as the World Bank, have committed to large amounts of funds for slum upgrading in Dhaka and continue to do so. These funds can be used to distribute the service spines allowing individual houses to be attached.

Through many large scale slum resettlement schemes, cities have found that uprooting the urban poor from their chosen sites often lead to the failure of the project since location is a key element to their survival. The amphibious houses should begin to be located in existing slum and squatter settlements to allow residents to continue the life they have constructed. As the typology becomes common in the city fabric, new houses can be located in the low lying east and west parts of the city. The amphibious house can be developed in land that was initially marked as unusable due to low elevations. Commercial units can easily be attached to the service spine to create commercial zones, leaving a lot of flexibility of design by urban planners. The prototype therefore is a small piece of a larger puzzle.

The amphibious houses are a solution that will prove to be extremely cost effective in the long term due to the benefits of sustainable architecture. The low maintenance of the primary structure constructed from concrete along with the little dependence on city grid for services such as water, sewage and electricity, make this project a viable long term solution. The demand for this new typology is expected to be very high because it provides a solution for the larger population of the city. A large number of employment and entrepreneur opportunities within local communities will be created by this demand. The MCR tiles opportunity is one example of a small business that can be started to meet the growing demands. The skills attained through the construction of these houses will provide basic training for residents that they can use towards future employment. For example, the 8 households from this prototype can form the majority of the construction crew for new houses constructed within the community.

Architects and engineers can use the prototype as a testing ground for amphibious structures which will prove to be an effective design solution for low lying areas around the world. Whether it is the low lying slums of Uganda, India or Pakistan, the problem of flood prone slums is one that is universal. The prototype will add valuable insights to the body of research conducted by the Netherlands, U.S. and Canada on amphibious structures. Unlike the work produced by these countries, the Dhaka project will apply the principles of buoyant foundations to inexpensive solutions that can be replicated with minimal changes to low-income dense urban centers prone to flooding.

BIBLIOGRAPHY:

- ALI M., HOQUE M.M., RAHMAN R., and RASHID S. (1998) *Bangladesh Floods – Views from Home and Abroad*, The University Press Limited, Dhaka
- BBS (2007) *Statistical Yearbook of Bangladesh 2007*, Bangladesh Bureau of Statistics, Dhaka
- BBS (2008) *Statistical Pocket Book 2008*, Bangladesh Bureau of Statistics, Dhaka
- BRAMMER H. (2004) *Can Bangladesh be Protected from Floods?* The University Press Ltd. Dhaka
- COUNTS A. (2008) *Small Loans, Big Dreams – How Nobel Prize Winner Muhammad Yunus and Microfinance Are Changing the World*, John Wiley & Sons, New Jersey
- ENAM K. and HOSSAIN M.A. (2007) *Search for an Affordable Shelter for Urban Poor*, AED Architecture for the Economically Disadvantaged, International Seminar 2007, Department of Architecture, BUET pg 165
- FATHY H. (1973) *Architecture For The Poor, An Experiment in Rural Egypt*, The University of Chicago Press, Chicago
- HARRISON P. (2007) *The space between us: opening remarks on the concept of dwelling*, Environment and Planning Department: Society and Space vol. 25 pg 625-647
- HUQ S. and ALAM M. (2003) *Flood Management and Vulnerability of Dhaka City*, Building Safer Cities, World Bank Publications Pg 121-127
- HUQUE I. (2005) *Urban Slum Mapping in Bangladesh*, Centre for Environmental and Geographic information Services Dhaka, Bangladesh (CEGIS)
- ISLAM N. (1996) *Dhaka: From City to Mega city*, Dana Printers Ltd. Dhaka
- KAMRUZZAMAN M. (2007) *Potential of High Density Walkup Apartments in Dhaka City*, Research Report for Department of Civil Engineering & Architecture
- KHAN A.H. *Squatter Resettlement Schemes in Dhaka*, Housing Limited Income Groups, Pg 97-100
- MAHMUD S. (2001) *The Interaction between Physical Space and the way of Life in Low-Income Settlements: Case of Bustees and Resettlement Camps in Dhaka*, Bilkent University, Faculty of Art, Design and Architecture. Unpublished Ph.D. dissertation, Ankara
- MAHMUD S. (2003) *Women and the transformation of domestic spaces for income generation in Dhaka bustees*, Elsevier Ltd, Great Britain

- MORSHED A. (2007) *Sharifa's House*, John Wiley & Sons, New Jersey
- NIJMAN J. (2008) *Against the Odds: Slum rehabilitation in neoliberal Mumbai*, Elsevier pg 73-85
- PANAYIOTA I. P. *Hassan Fathy Revisited Postwar Discourses on Science, Development, and Vernacular Architecture*, University of Illinois at Urbana-Champaign
- PICCHI F. (2007) *Self-service City*, Domus vol. 904, pg 65
- RAHMAN M. M. (1999) *Squatters and housing rights*, The Daily Star, Dhaka, 24 September, pg 7
- RAHMAN M. M. (2002) *Bastee Eviction and Housing Rights: A Case of Dhaka, Bangladesh*, the Blackwell City Reader, Blackwell Publishing, Berlin
- RAHMAN M. M. (2007) *Politics of Housing in Bangladesh*, AED Architecture for the Economically Disadvantaged, International Seminar March 23-24, Department of Architecture
- RICHARDS J.M., SERAGELDIN I. and RASTOFER D. (1985) *Hassan Fathy*, Concept Media, London
- RUDOFISKY B. (1964) *Architecture without Architects – A Short Introduction to Non-Pedigreed Architecture*, Doubleday & Company, New York
- SCHUMACHER E.F. (1993) *Small is Beautiful – A study of economics as if people mattered*, Cox & Wyman Ltd. U.K.
- SHAMSAD B. and SHAMSAD S. (2007) *Impacts of Slum Upgrading Projects on the Urban Poor: The Case of Slums in Khulna, Bangladesh*, AED Architecture for the Economically Disadvantaged, International Seminar March 23-24, Department of Architecture
- SHARMEEN F. and PARVIN G.A. (2007) *Training and Home for Home Based Income sGeneration for Urban Poor Women*, AED Architecture for the Economically Disadvantaged, International Seminar 2007, Department of Architecture, BUET pg 113
- SHELTEC CONSULTANTS Ltd. (2007) *Study for Rehabilitation of Dwellers at Sattala Bastee Area*, Dana Printers Limited, Dhaka
- ULLAH A.A., RAHMAN A. and MURSHED M. (1999) *Poverty and Migration – Slums of Dhaka City The Realities*, Association of Rural Development and Studies, Bangladesh
- WORLD WATCH INST. (2007) *State of the World – Our Urban Future*, Worldwatch Inst., Washington

APPENDIX: A.2 LIFT BROCHURE



**The TR Series is An Innovative
Lift for working on your home
without the use of ladders or scaffolding.**

The TR Series is a revolutionary lift that is designed for the home user. It is a compact, easy-to-use lift that can be used for a wide range of tasks. It is a great alternative to ladders and scaffolding. It is a great choice for anyone who wants to work on their home safely and easily.

**The TR Coverage: A revolutionary design
built on a platform for floor joists that
breaks up into many levels.**

- The TR Series is a revolutionary lift that is designed for the home user.
- The TR Series is a revolutionary lift that is designed for the home user.
- The TR Series is a revolutionary lift that is designed for the home user.
- The TR Series is a revolutionary lift that is designed for the home user.
- The TR Series is a revolutionary lift that is designed for the home user.
- The TR Series is a revolutionary lift that is designed for the home user.
- The TR Series is a revolutionary lift that is designed for the home user.
- The TR Series is a revolutionary lift that is designed for the home user.



The TR Series is a revolutionary lift that is designed for the home user. It is a compact, easy-to-use lift that can be used for a wide range of tasks. It is a great alternative to ladders and scaffolding. It is a great choice for anyone who wants to work on their home safely and easily.

The TR Series is a revolutionary lift that is designed for the home user. It is a compact, easy-to-use lift that can be used for a wide range of tasks. It is a great alternative to ladders and scaffolding. It is a great choice for anyone who wants to work on their home safely and easily.



TR Series
Lifts
Call 1-800-555-1234
www.trseries.com

The TR Series is a revolutionary lift that is designed for the home user. It is a compact, easy-to-use lift that can be used for a wide range of tasks. It is a great alternative to ladders and scaffolding. It is a great choice for anyone who wants to work on their home safely and easily.

The TR Series is a revolutionary lift that is designed for the home user. It is a compact, easy-to-use lift that can be used for a wide range of tasks. It is a great alternative to ladders and scaffolding. It is a great choice for anyone who wants to work on their home safely and easily.

APPENDIX: A.3 LIFT PROPOSAL BOOKLET



The lift house (low income flood-proof technology) pilot project was designed and constructed by Prithula Prosun in Dhaka, Bangladesh as an innovative solution for sustainable housing for low income communities in flood prone areas.

Millions are displaced and many lose lives during severe floods due to the overflowing of rivers, inadequate drainage and monsoon rain in Bangladesh. Bangladesh occupies the deltaic floodplains of two of the world's largest rivers, and responsible for draining large volumes of water from surrounding countries, including the Himalayas. Severe floods in Dhaka are mainly caused by overflow of surrounding rivers, as well as internal water logging. In recent history, the city experienced major floods due to overflow of surrounding rivers in the following years: 1954, 1955, 1970, 1980, 1987, 1988, 1998 and 2004. Among these, the 1988 flood had inundated 85% of the city with depths ranging from 0.3-4.5 meters affecting 60% of the city dwellers. Experts of climate change predict that flooding will worsen as the Himalayan glaciers melt at an increased rate pushing excess water through the river systems of Bangladesh. Floods cause the most damage to the low income population who live in informal settlements throughout the urban centers of the country. More than ever, concerns for global warming have brought the issues of flood mitigation to the forefront for low lying areas around the world. Experts predict that a one-meter rise in sea level in Bangladesh will result in a loss of 17.5% of land area, affecting 13 million people. At the current state, the city is unable to adapt to the rising water levels from floods, and the added stress of rising sea level due to climate change will be catastrophic.



Table 1: Population and Area of Dhaka City DMDP, 1947-2025

Year	Population (roundoff)	Area in sq. km	Political Administrative Identity
1947	200,000	23	Dhaka City (Capital of East Pakistan)
1971	900,000	323	Dhaka City (Capital of Bangladesh)
1974	1,017,000	323	Dhaka Statistical Metropolitan Area (DSMA)
1981	1,440,000	401	Dhaka Statistical Metropolitan Area (DSMA)
1991	2,648,000	1,353	Dhaka Statistical Metropolitan Area (Dhaka Megacity)
2001	8,900,000	1,353	Dhaka Megacity
2004	12,000,000	1,350	Dhaka Metropolitan Development Plan Area (RAJUK Av.)
2005	12,820,000	1,350	Dhaka Metropolitan Development Plan Area (RAJUK Av.)
2010	14,200,000	1,350	Dhaka Metropolitan Development Plan Area (RAJUK Av.)
2015	15,870,000	1,350	Dhaka Metropolitan Development Plan Area (RAJUK Av.)
2016	20,000,000	1,350+	Dhaka Metropolitan Development Plan Area (RAJUK Av.)
2020	25,000,000	1,350+	Dhaka Metropolitan Development Plan Area (RAJUK Av.)
2025	30,000,000	1,350+	Dhaka Metropolitan Development Plan Area (RAJUK Av.)

Source: Various Census Reports and Maps: Dhaka From City to Megacity, 1996 and DPSP, 2004

Rapid urbanization has led to more intense floods and incurred damages. Today more than 25% of the total population of the country lives in urban areas with Dhaka containing 40% of the national urban population. Dhaka is the fastest growing mega city in the world. Due to rural-urban migration amongst other factors, the city of Dhaka has experienced rapid growth since 1972, after its transformation from a provincial capital to the national capital of the newly independent country, Bangladesh. An estimated 300,000 to 400,000 new migrants, mostly poor, arrive

to the city annually. Dhaka is unable to provide basic services to its residents with over 35% of the population living in slums and squatter settlements, from which 60% live in flood prone areas.



This study was conducted by Prithula Prosun to find a solution to the urgent housing needs of the poor, both in Dhaka and its surrounding areas in order to alleviate the attraction of rural-urban migration. The study resulted in the design and construction of the lift house pilot project that provides flood protected, affordable housing for low income families.

AN INNOVATIVE SOLUTION

The lift Concept: A sustainable house built on ground for flood prone areas that floats up with rising water levels

- The house does not interfere but works with the natural environment
- The service spine provides year round access to water, electricity and sanitation without connection to city services
- The dwelling is attached to the service spine with a steel vertical guidance system that restricts horizontal movement and tipping during floods
- Potential for micro businesses are created by using local and recycled materials
- Treated bamboo is used with modern jointing techniques for extended life and structural integrity
- The two storey dwellings allow dense communities with shared service spaces
- The project is designed to protect the lifestyle of low income families



The lift house pilot project was constructed within the boundaries of the Housing and Building Research Institute in Dhaka for two families. The project was inaugurated in January 2010 by the Agriculture Minister, Moityar Chowdhury, in the presence of the chief guest Finance Minister, Abul Maal Abdul Muhit and Public Works State Minister, Advocate Abdul Manan Khan. The lift house floats upwards with rising water levels due to floods and water logging, and returns to ground level as the water recedes. The design stands as a new prototype for an environmentally conscience low income urban community.

Buoyancy is achieved by two different types of foundations that allow the house to float on water. The application of used empty plastic water bottles are packed into the foundation to provide buoyancy for one dwelling and a hollow Ferro cement foundation is used for buoyancy in the second dwelling.

With the consequences of Dhaka's environmental exploitation in sight, the lift house is designed with a unique approach to its architecture where the house is completely self sustaining and independent to the city's service systems.

The lift house provides all services to its residents throughout the year, including water collection and filtration, electricity and composting toilets. In order to avoid the use of deep tube wells, which are extremely harmful to Dhaka's groundwater level, the service spine collects and filters rainwater and further recycles this water. Electricity is derived from two 60W solar panels for lighting and fans. The shared composting toilet allows the residents to create compost from human waste that can be sold or applied to the vegetable garden after 10 years of use. Urine is directed from the toilet to the garden as a source of nutrients through an underground pipe system.

The service spine is a static structure constructed out of brick and concrete that holds the water tanks and composting storage, and provides the vertical guidance and stability to the two attached amphibious dwellings so that the floating amphibious bamboo structures do not tip over during strong winds.

Bamboo is a fast growing local renewable resource that was used to construct the two dwellings. Bamboo is promoted as a green material, and the typical low cost choice of corrugated tin is rejected for its inappropriateness to the climate. Unlike corrugated tin that become a life hazard during storms and overheats during the summer months, bamboo creates a safe and comfortable environment that is affordable to the low income groups. As one of the fastest growing materials in the world, bamboo is easy to produce with very little technology. Comparable to steel in tension and concrete in compression, this natural material has the potential to create many local jobs. The lift house pilot project used bamboo in many different forms to exhibit its potential as an inexpensive aesthetically pleasing material that can be readily used in Bangladesh's context. Through the extensive use of bamboo, the project employed local labour, and enhanced local traditional skills through on-site training. Bamboo is quickly becoming a chosen material for architects and designers all over the world as a green material, and the lift organization strongly believes that Bangladesh can take a leadership role in promoting this material through good design and production of bamboo.

WHAT CAN YOU DO?

lift invites the Government of Bangladesh, NGOs, Banks and private donors to come forward and help in the implementation of future lift communities. The lift organization is fully equipped to provide services to the low income families of Bangladesh to provide safe and permanent housing as a tool to alleviate poverty with the help of a funding source.

The lift project has considered the following key issues in proposing a community of 100 units:

1. Land

The provision of land for the proposed housing project can be donated by the Government or khas land can be leased.

2. Finance

The cost of constructing a lift community with 8-20 units is TK 250 000/unit. The implementation of a larger community will decrease the cost. If we consider building 100 units, the cost will be approximately TK 200,000/unit. The following financing options are possible:



Option 1:

A lift community is financed as a humanitarian act by corporations, NGOs and private donors, or as a project adopted by the Government where the residents receive property rights at occupancy.

Option 2:

A bank provides a mortgage loan for the construction of a lift community with a minimal interest rate which would be paid back in full within a period of 15 years after which the residents will receive full property rights.

Option 3:

An NGO or a corporation pays the cost of building a lift community. After occupancy the residents pay a monthly rent which in 10-15 years can pay back the full cost, after which the residents will receive full property rights.

	Number of Units	8 - 20 units		Over 100 units	
		Amount Paid By Residents	Repayment Period	Amount Paid By Residents	Repayment Period
Option 1	Subsidized, NGO, Corporation and Private Donors	0	0 years	0	0 years
Option 2	Bank with mortgage	1390+interest	15 years	1670+interest	10 years
Option 3	NGO, Corporation and	1400	15 years	1700	10 years

All amounts are expressed in BDT

NEXT STEPS

Interested parties need to communicate in a round table conference where the goals and scope of the project can be discussed. The lift organization can organize meetings in Dhaka amongst the following groups:

- a Bangladesh Bank Authority
- b Private and Public Banks
- c Government Authority
- d NGOs
- e Private or Commercial Donors
- f lift Organization

The steps following will include meeting and communicating with beneficiaries, contract between stakeholders, locating a site, choosing an implementation method, design and construction of a lift community, and occupancy.

Contact the lift organization if you are interested in implementing a lift community:

- A: Tower Hamlet, 6th Floor, 16 Kemal Ataturk Avenue, Banani, Dhaka-1213
- T: 8836102, 01730-316889, 01730-316890

**APPENDIX: A.4
LIFT HOUSE PILOT PROJECT CONSTRUCTION COST**

Civil Work			350,000 TK	\$ 5380 CAD
bricks		90,000 TK	1380 CAD	
concrete		120,000 TK	1850 CAD	
labour		85,000 TK	1300 CAD	
Bamboo Work			200,000 TK	\$ 3075 CAD
bamboo		100,000 TK	1540 CAD	
used steel rods		50,000 TK	770 CAD	
labour		50,000 TK	770 CAD	
Mechanical Work			85,000 TK	\$ 1300 CAD
Plumbing Work			5000 TK	\$ 80 CAD
Security			10,000 TK	\$ 155 CAD
<hr/>				
TOTAL COST OF LIFT HOUSE WITH TWO UNITS			650,000 TK	\$ 10,000 CAD
COST PER UNIT			325,000 TK	\$ 5,000 CAD

BIBLIOGRAPHY

Afsar, Rita. *Rural-Urban Migration in Bangladesh.* Dhaka: The University Press Ltd, 2000

Ahmed, Alauddin. *Migration of Rural Poor to Urban Slums and Their Poverty Situation.* Comilla: Popular Printing Works, 2004

Alini, Luigi. *Kengo Kuma.* Milan: Electra, 2005

Ali, Mir. M, M. Mozzammel Hoque, Rezaur Rahman and Salim Rashid. *Bangladesh Floods – Views from Home and Abroad.* Dhaka: The University Press Ltd., 1998

Austin, Robert and Koichiro Ueda. *Bamboo.* Tokyo: Weatherhill, 1985

Bamboo Central. (Accessed November 2010) <http://www.bamboocentral.org/whybamboo.html>

Bangladesh Bureau of Statistics. *Statistical Yearbook of Bangladesh 2007.* Dhaka: Bangladesh Bureau of Statistics, 2008

Bognar, Botond. *Material Immaterial.* New York: Princeton Architectural Press, 2009

Bognar, Botond. *Kengo Kuma Selected Works.* New York: Princeton Architectural Press, 2005

Brammer, Hugh. *Can Bangladesh be Protected from Floods?* Dhaka: The University Press Limited, 2004

Buoyant Foundation Project. (Accessed October 2010) <http://www.buoyantfoundation.org/>

Centre for Urban Studies (CUS). *Slums of Urban Bangladesh.* Dhaka: CUS, National Institute of Population Research and Training (NIPORT) and Measure Evaluation, 2005

Choguill, Charles L. *New Communities for Urban Squatters – Lessons from the Plan That Failed in Dhaka, Bangladesh.* New York: Plenum Press, 1987

Counts, A. *Small Loans, Big Dreams - How Nobel Prize Winner Muhammad Yunus and Microfinance Are Changing the World,* New Jersey: Jon Wiley & Sons

Desai, Vandana. *Community Participation and Slum Housing – A Study of Bombay.* New Delhi: Sage Publications Pvt. Ltd., 1995

Enam, Khairul and Afzal Hossain. “Search for an Affordable Shelter for Urban Poor” *AED - Architecture for the Economically Disadvantaged.* 165-170, Dhaka: Department of Architecture, Bangladesh University of Engineering and Technology (BUET), 2007

English, Elizabeth. *Amphibious Foundation and the Buoyant Foundation Project: Innovative Strategies for Flood-resilient Housing.* Paper presented at the International Conference on Urban Flood Management sponsored by UNESCO- IHP and COST Action C22, “Road Map Towards a Flood Resilient Urban Environment”, November 25-27, Paris, France: 2009

Feireiss, Kristin. *in Times of Architecture Need.* New York: Prestel Publishing, 2009

FloatingCommunities.com (Accessed October 2010) http://www.floatingcommunities.com/cgi-bin/bizdbsearch.cgi?template=article_uk&dbname=fc_uk&f1=18&action=searchdbdisplay

Goldberg, Gale Beth. *Bamboo Style.* Great Britain: Gibbs Smith Publisher, 2002

Grameen Shakti. (Accessed July 2009) http://www.gshakti.org/index.php?option=com_content&view=article&id=59&Itemid=63

Guarneri, Andrea Bocco. *Bernard Rudofsky – A Humane Designer.* Vienna: Springer- Verlag/Wien, 2003

Halong Bay Vietnam. (Accessed October 2010) <http://www.halongbay-vietnam.com/photos/people.htm>

Hofer, Thomas and Bruno Messerli . *Floods in Bangladesh - History and Dynamics and Rethinking the Role of the Himalayas.* New York: United Nations University, 2006

Huq, Bashirul. *Battling the Storm - Study on cyclone resistant housing.* Dhaka: German Red Cross, 1999

Huq, Saleem and Mozaharul Alam. *Flood Management and Vulnerability of Dhaka, Building Safer Cities.* Dhaka: World Bank Publications, 2003

Islam, M. Aminul. *Environment Land Use and Natural Hazards in Bangladesh.* Dhaka: Dhaka University, 1995

Kennedy, Joseph F. *Building Without Borders – Sustainable Construction for the Global Village.* Canada: New Society Publishers, 2004

Khandker, Shahidur R. *Fighting Poverty with Microcredit, Experience in Bangladesh.* Dhaka: The University Press Ltd., 1998

Kuma, Kengo. *Kengo Kuma – Materials, Structures, Details.* Basel: Birkhauser, 2004

Mahmud. *River Life: Bangladesh.* Dhaka: Map/Matri, 2004

Mahmud, Shihabuddin. “Women and the transformation of domestic spaces for income generation in Dhaka bastees.” *Cities*, Vol.20, No.5, Elsevier Ltd., 2003

Mallick, Fuad H and Khondaker Hasibul Kabir. “Aspiring above the line: Spaces in Rural Homesteads of Bangladesh.” *AED - Architecture for the Economically Disadvantaged* 14-18. Dhaka: Department of Architecture, BUET, 2007

METI School. (Accessed July 2009), http://www.meti-school.de/daten/projektbeschreibung_e.htm

Morris, Dale, David Waggoner and Han Meyer. *Dutch Dialogues: New Orleans - Netherlands, common challenges in urbanized deltas.* New Orleans: SUN, 2009

Mowla, Qazi Azizul and Mohammed Sazzad Hossain. “Living Environment for Dhaka’s Urban Poor - An Analysis” *AED - Architecture for the Economically Disadvantaged.* 8-13, Dhaka: Department of Architecture, BUET, 2007

Paul-Majumder, Pratima, Simeen Mahmud and Rita Afsar. *The Squatters of Dhaka City – Dynamism in the Life of Agargaon Squatters.* Dhaka: The University Press Ltd., 1996

Peace of Angkor. (Accessed August 2010), <http://www.peaceofangkorweb.com/TonleSap.htm>

Rahman, Dr Mahbubur. “Politics of Housing in Bangladesh.” In *AED - Architecture for the Economically Disadvantaged.* 78-87 Dhaka: Department of Architecture, BUET, 2007

Rahman, M. Atikur. *Adibashi Shampradoy.* Dhaka: Advent Printers, 2004

Rudofsky, Bernard. *Architecture without Architects – A Short Introduction to Non-Pedigreed Architecture.* New York: Doubleday & Company, Inc., 1964

Schonning, Caroline. *Urine Diversion - Hygienic risks and microbial guidelines for reuse.* PhD. thesis, Department of Biotechnology, Royal Institute of Technology, Stockholm, Sweden, 2001

Shahjahan, M. *Flood Disaster Management in Deltaic Plain Integrated with Rural Development, Bangladesh Floods.* Dhaka: The University Press Limited, 1998

Sharmeen, Fariya and Gulshan Ara Parvin. “Training and Home for Home Based Income Generation for Urban Poor Women.” *AED - Architecture for the Economically Disadvantaged.* 113-117, Dhaka: Department of Architecture, BUET, 2007

Bangladesh Bureau of Statistics. *Statistical Yearbook of Bangladesh 2007.* Edited by Jafar Ahmed Chowdhury et al. Dhaka: Bangladesh Bureau of Statistics, 2008

Sulabh Toilets, “Sulabh Flush Composting Toilet”, http://www.sulabhinternational.org/st/sulabh_flush_compost_toilet.php. (Accessed July 2009)

The Worldwatch Institute. *State of the World – Innovations for a Sustainable Economy.* Washington: Norton & Company, 2008

The Worldwatch Institute. *State of the World - Our Urban Future.* Washington: Norton & Company Inc., 2007

Team members of URBIS project and University of Asia Pacific. *Low Cost Housing Design for the Urban Poor.* Dhaka: Centre for the Urban Studies, 2007

Ullah, AKM Ahsan, Abdar Rahman and Munira Murshed. *Poverty and Migration - Slums of Dhaka, The Realities.* Dhaka: Association for Rural Development and Studies, 1999

Velez, Simon. *Grow Your Own House, Simon Velez and Bamboo Architecture.* Geneva: Vitra Museum and Autoren, 2000

World Bank. *Building Safer Cities.* Edited by Alcira Kreimer, Margaret Arnold, and Anne Carlin. Washington: The International Bank for Reconstruction and Development/The World Bank, 2003

Yunus, Muhammed and Alan Jolis. *Banker to the Poor – The autobiography of Muhammad Yunus, founder of the Grameen Bank.* Dhaka: The University Press Ltd., 1998